

HISTORIC FARMSTEADS

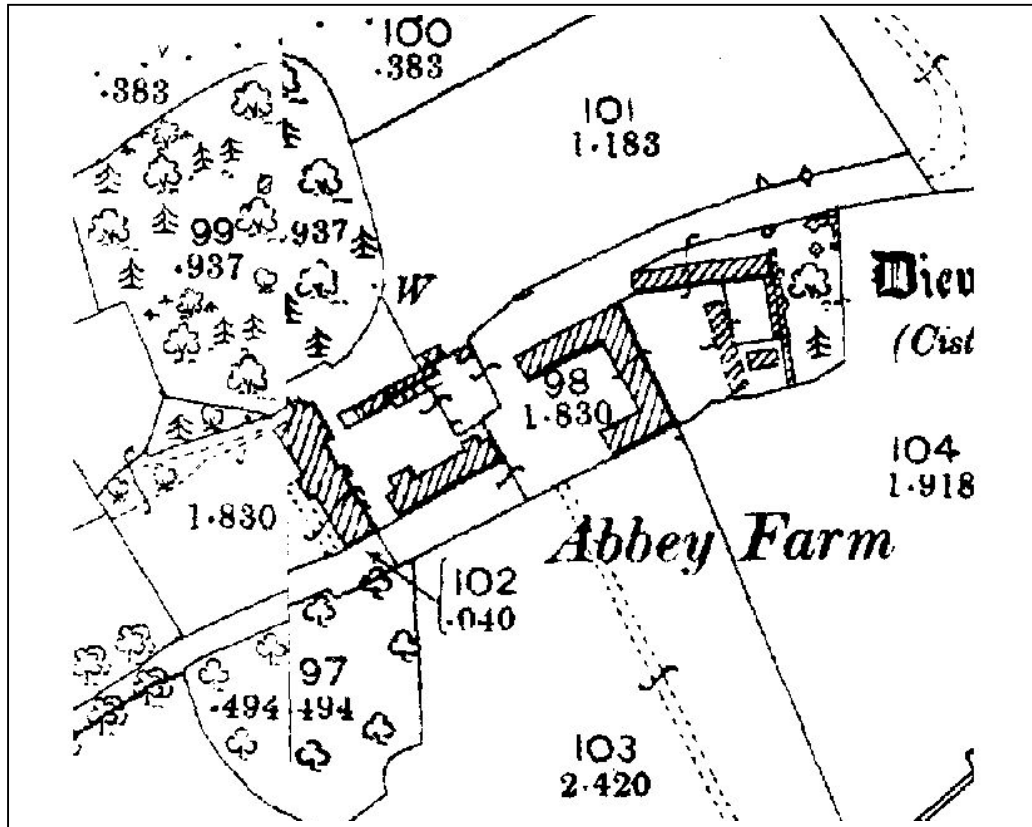

A MANUAL FOR MAPPING



ENGLISH HERITAGE

FORUM
Heritage
Services

HISTORIC FARMSTEADS

A MANUAL FOR MAPPING

by

Jeremy Lake & Bob Edwards



FORUM
Heritage
Services

CONTENTS

	Preface	
1.0	Introduction	1
2.0	Aims of Farmstead Mapping	1
3.0	Background	2
3.1	Farmstead Development	2
3.2	Landscape and Settlement	3
3.3	Introducing Farmstead Form and Function	4
4.0	Data Requirements	6
4.1	Ordnance Survey mapping	6
4.2	Historic Building Data	6
4.3	Address Point Data	6
4.4	Aerial Photography	6
5.0	Mapping Farmsteads	7
5.1	Farmsteads, Outfarms and Field Barns	7
5.2	Farmstead Date	7
5.3	Farmstead Plan	7
5.4	How to Record Plan Type	8
6.0	Description of Plan Types	11
6.1	Loose Courtyard Plans	11
6.2	Regular Courtyard Plans	13
	Full Regular Courtyards	14
	Regular L-Plans	15
	Regular U-Plans	16
	Regular E, F, T, Hand Z-Plans	17
	Regular Multi-Yard Plans	19
	Covered Yards	20
6.3	Dispersed Plans	21
	Dispersed Cluster Plans	21
	Dispersed Multi-Yard Plans	24
	Dispersed Driftway Plans	25
6.4	Small Plan Types	26
6.5	Linear and L-Plan (House Attached) Plans	26
	Parallel Plans	28
	Row Plans	28
7.0	Small-holdings, Outfarms and Field Barns	29
7.1	Small-holdings	29
7.2	Outfarms and Field Barns	30
8.0	Mapping other Attributes	31
7.1	Farmhouse Position	31
7.2	Change	31
7.3	Modern Sheds	31
7.4	Farmstead Location	33
7.5	Size	33
7.6	Confidence	33
7.7	Notes	33
9.0	Analysis and Reporting	34
10.0	Template for Character Area Descriptions	35

Text © English Heritage and Bob Edwards 2008
Historic OS provided by English Heritage © and database right Crown Copyright and Landmark
Information Group Ltd (All rights reserved 2009) Licence numbers 000394 and TP0024.
Photographs © Bob Edwards except Figures 15, 24 and 32 © English Heritage/
Michael Williams
Line drawings produced by Donna Scott © High Weald AONB Unit (except Figure 51)

PREFACE

This guide has been put together in order to guide the work of key partners in the West Midlands region, where English Heritage and the Regional Development Agency (Advantage West Midlands) are funding as part of a broader project the mapping of historic farmsteads. The principal aim of the *Farmsteads in the West Midlands* project is to:

1. develop an integrated understanding - for the first time across a government region - of farmstead character, survival and current use within their landscape and settlement context;
2. understand and demonstrate how farmsteads contribute to local distinctiveness and landscape character;
3. understand the present use and social/economic role of historic farmsteads;
4. inform strategic policy and guidance, and the drafting of local policy and guidance.

It builds on the results of several years of research and new policy on farmsteads (summarised on the English Heritage HELM and Characterisation Team websites) which has highlighted the importance of three principal priorities to address:

1. Understanding the present inherited patterns of farmstead character.
2. Understanding the forces for present and future change.
3. Developing place-making tools.

The key products will be:

1. *Farmsteads Mapping*, through the creation of a data set utilising GIS, capable of analysis against landscape-scale datasets such as Character Areas/Types and Historic Landscape Characterisation.
2. *Mapping Current Use and Context*, through the provision of work in progress on developing the evidence base and data that reveals the current social and economic role of farmsteads.
3. A *character framework* in the form of regional and character area guidance that enables users to understand farmsteads in their local-regional-national context.
4. *Planning tools* based on an understanding of the potential for and sensitivity to change of farmsteads and their buildings, both at a strategic and a site-based level, and that enable local authorities to develop guidance.

This manual is intended to guide and ensure consistency in the creation of Farmsteads Mapping process and the creation of a dataset. This builds on pilot work in Hampshire, Sussex and the High and Low Weald of Kent, which has explored and refined methods for the rapid mapping of farmsteads by date, survival and type in relationship to historically conditioned landscape character and type. It is intended that, as a result of use in the West Midlands and in other parts of the country, it will be revised as a guide for application nationally.

Thanks are due to Amanda Smith and English Heritage's West Midlands team for their support for this guide, to county-based colleagues in the region for their comments on the initial draft and to the High Weald AONB Unit for their permission to reproduce Donna Scott's farmstead drawings.

Jeremy Lake, Characterisation Team, English Heritage
Bob Edwards, Forum Heritage Services
January 2009

HISTORIC FARMSTEADS: A MANUAL FOR MAPPING

1.0 INTRODUCTION

Local distinctiveness results from the inter-relationship of a great diversity of patterns and forms. Elements such as the shape, form and constructional techniques of buildings will be repeated elsewhere but rarely in the same combination.

Farmsteads make a major contribution to local distinctiveness, through their varied forms, use of materials and the way that they relate to the surrounding form and patterning of landscape and settlement. Their character has been shaped by their development as centres for the production of food from the surrounding farmland, and other factors such as wealth and landownership, responses to regional and national markets and cultural traditions.

Understanding the character of a farmstead should consider at the outset:

1. their landscape context;
2. their overall planning and scale, including patterns of access to, within and around the steading.

Looking at the whole character of farmsteads in this way enables us to understand and question their relationship to the wider landscape, and the extent to which in turn they have retained traces of the past. Observation of the site itself can then show:

3. how functions are expressed in the types of buildings;
4. building materials.

The guidance in this document therefore considers (in section 3) the chronological and landscape context of farmsteads, prior to the data requirements (in section 4) and (in sections 5-6) how their functions are expressed in the patterns of farmstead types observable from modern and historic mapping and aerial photography. Highlighting the importance of historic farmsteads to the character of the landscape has been a major theme of the work of the Characterisation and Policy Teams of

English Heritage in recent years. Their work has led to the production of a revised Policy document on historic farmsteads (*Living Buildings in a Living Landscape*) and Preliminary Farmstead Character Statements for each region.

At a more local level, English Heritage has encouraged and supported the development of methodologies to examine and describe the character of farmsteads and their relationships with landscape character and historic landscape character. This has included the development of Farmstead Character Statements using the landscape Joint Character Areas as a framework and an assessment framework to assist in the understanding and reporting of local distinctiveness.

One of the principal tools for this work has been the mapping of farmsteads shown on late 19th century historic maps, recording plan form, utilising listed building information to understand time depth and assessing the degree of change when compared to modern Ordnance Survey mapping. Such detailed mapping has been carried out in Hampshire, West Sussex, East Sussex, the High Weald AONB and, most recently, in Staffordshire. This work is now being taken forward by the West Midlands Team with support from the Regional Development Agency, Advantage West Midlands, to provide the first coverage full coverage of farmsteads within a government region.

2.0 AIMS OF FARMSTEAD MAPPING

The aim of farmstead mapping is to provide a consistent understanding of farmstead character at a landscape level, through recording the distribution, plan type and degree of change seen between historic mapping and the present. The mapping and subsequent analysis can be used in a number of scenarios including:

- The development and support of land use policy including Supplementary Planning Documents;
- Inform and assist the strategies of Rural Development Agencies and local authorities with regard to the options for re-use of redundant farmstead buildings;
- Inform discussions on the sustainability of rural settlements;
- The targeting of Higher Level Stewardship;
- Assist landowners, managers and advisors with Farm Environment Plans and applications;
- Provide the context and understanding for applications relating to applications relating to individual farmsteads.

Supporting many of these objectives will be a series of Farmstead Character Statements based on the Joint Landscape Character Areas (JCAs). These will be based upon the synthesis and analysis of existing published evidence, except where the mapping exercise has been completed. A guide to the format and content of the Character Statement can be found in Section 10, below

This manual has been developed to provide guidance for local authorities and other organisations wishing to undertake the mapping of farmsteads. One of the main aims of setting out the methodology used for the mapping projects undertaken to date is to try, as far as possible, to standardise data collection so that it is consistent and can be used at a regional or national scale.

The manual will initially present a brief overview of the historical and landscape context of farmsteads prior to an analysis of farmstead form and function. This is followed by consideration of the methodology for recording farmsteads and examples of the process of analysis undertaken to date.

3.0 BACKGROUND

3.1 Farmstead Development

All working farmsteads show a clear distinction between wide-span multi-purpose sheds, dating from the 1950s and which are vital to the modern industry, and earlier more specialised buildings which in their scale, form and use of

materials more closely resemble the domestic and industrial architecture of their surrounding areas (see Table 1). For a summary of agricultural history, both at a national level and regionally, see the Regional Preliminary Character Statements available at www.helm.org.uk.

TABLE 1 Principal building phases at a national level

<p><i>Present to 1950</i> Wide-span multi-purpose sheds have since the 1950s been increasingly vital to the modern farming industry, because they facilitate labour-efficient on-farm production and the housing of stock that satisfy animal welfare standards. These sheds are either sited on the farmstead perimeter or replaced earlier buildings, and can relate to new access routes and concreted areas of hard standings.</p>
<p><i>1950-1880</i> There was little fresh investment due to the long farming depression in this period, notable exceptions being some estates, the modernisation of dairy farms and in the inter-war period the intensive rearing of pigs and poultry.</p>
<p><i>1880-1750</i> Most farm buildings date from this period and in particular the capital intensive 'High Farming' years of the 1840s to 1870s. Farmsteads were subject to substantial rebuilding or new development over this period, especially in the 19th century when the production of farmyard manure by cattle played a major role in increasing agricultural productivity. Some farmsteads were built in landscapes affected by enclosure of common land or the small remaining proportion of communal strip fields.</p>
<p><i>Before 1750</i> Substantially complete farm buildings of this period are rare: typically only the farmhouse and barn survive. Buildings can display clear local and regional variations, reflecting the development from the medieval period of distinct agricultural zones linked to the regional and national markets. Most survivals are high status, and include barn and other buildings on monastic and ecclesiastical estates pre-dating the Dissolution of the 1530s-40s.</p>

3.2 Landscape and Settlement

Local character and distinctiveness has been shaped by historical patterns of land use and settlement. The scale and patterns of enclosure of fields by hedgerows, walls and banks in the present-day farming landscape, and their relationship to the siting of isolated farmsteads, dwellings and settlements, can reveal how the land and its resources was farmed, exploited and managed in the past.

The distribution of farmsteads and dwellings within individual townships or parishes occupies a broad spectrum of patterns, ranging from nucleation (where the land is dominated by villages with few or no isolated farmsteads); in between there is a range of mixed settlement patterns (with hamlets and isolated farmsteads and dwellings) to dispersed settlement dominated by scattered dwellings and farmsteads. These patterns reflect the extent to which farmers worked the land on a communal, co-operative or individual basis, from farmsteads based in villages, hamlets or isolated sites. This is because land was farmed in common (for grazing, fuel and other products) or as fields enclosed into individual units: patterns of enclosure reveal the chronological depth of the present landscape, including the extent to which the land was subdivided into strips, which around villages were typically arranged in large open fields. By the middle of the 19th century, and much earlier in some parts of the country, piecemeal or planned enclosure by individual farmers and landlords had replaced strip fields and large areas of common land. Farmsteads in many areas became larger, and could be established on new sites that served these newly-enclosed fields.

Nucleated villages are concentrated in a central band running from Northumberland into Somerset and Dorset. Farmsteads were sited within these villages, which were surrounded by extensive communally farmed townfields (open fields). These were subject to amalgamation and enclosure by tenants and landlords at varying rates from the 14th century onwards. New farmsteads were often created within the new enclosures. Farmsteads in areas dominated by dispersed settlement are either isolated or grouped in hamlets. They are

typically surrounded by much more ancient patterns of enclosure, which included communally farmed townfields, and extensive areas of common pasture. Dispersed settlement is dominant in western and parts of eastern and south-eastern England.

Farming history has affected the size of farmsteads, and variations in their density and distribution in relationship to these patterns of inherited landscape character. A key feature of farming history since the medieval period has been the development of local and regional markets, and the development of areas that were mixed in their agriculture or which specialised in the production of corn, the rearing and fattening of cattle, and dairy products. Corn-producing arable farms were typically much larger in scale than pastoral farms, and more likely to employ wage labour. As a result, isolated farmsteads in landscapes of nucleated settlement subject to large-scale and regular enclosure in the late 18th and 19th centuries will typically be very sparse; those that exist often being late-comers to the landscape where farmsteads have moved out from the villages to sites within the newly enclosed fields. The highest densities of isolated farmsteads and hamlets tend to be concentrated in landscapes cleared by the 14th century from woodland, moor and marsh, which may retain small-scale and irregular patterns of enclosure.

3.3 Introducing Farmstead Form and Function

The functions of farmsteads have over time influenced their scale and form.

The historical function of the farmstead was to:

- accommodate the farming family in the farmhouse
- accommodate workers in the farmhouse, in the upper floors of buildings or in separate cottages
- store and process harvested crops such as corn (into grain), apples (into cider), and hops for the brewing industry
- provide shelter for horses or oxen for ploughing and other tasks
- shelter and manage livestock and store their fodder
- produce manure to fertilise the fields
- produce milk, cheese and butter
- store and shelter carts, implements etc
- sometimes manufacture non-agricultural produce, such as cloth, linen and iron.

These key functions required:

- **access** to routes and tracks, for communicating with local markets and communities, carting manure to surrounding farmland, moving livestock (particularly cattle) and bringing harvested hay, corn and other crops to the steading.
- **spaces** within and around the farmstead for moving, storing and managing farm products and animals – cattle yards and areas for stacking corn, hay, timber etc, gardens, orchards, ponds, small field enclosures for milking or sorting sheep and cattle.
- **different types and size of building.** The scale, range and form of working buildings reflects their requirements for internal space and plan form, lighting and fittings. Some buildings were detached and highly specialised in function (such as dovecotes, pigsties and threshing barns) whilst others combined in the individual rooms or in inter-linked ranges two or more functions.
- **The siting and orientation of working and domestic buildings.** The house was either detached from or integrated within the group, with a shared or separate entrance.

- **Hierarchies of form and scale,** the house and barn (for storing and processing the corn crop, and sometimes other functions as well) being the principal buildings on most farmsteads.
- **Internal spaces and detail**

These requirements were all subject to a huge amount of regional and local variation and, depending on the size and type of farm, are expressed in a variety of built forms and spaces (Tables 2 and 3).

TABLE 2 Principal farmstead types

Farmsteads vary enormously in their scale and the extent to which they incorporate elements of more than one plan type.

Dispersed plans

Typically show little evidence of planning in the arrangement of the buildings which may be loosely clustered in a group, consist of a number of scattered yards, often with no clear focal yard area and some are sited along a track.

Loose courtyard plans

These have developed in piecemeal fashion around one or more sides of an open cattle yard, and comprise detached buildings or more rarely inter-linked ranges.

Regular courtyard plans

Regular courtyard plans typically consist of carefully planned linked ranges and often result from a single phase of building. Farmsteads can be arranged as a full courtyard enclosing four sides of the yard or a number of ranges forming, for example, L-, U-, and E-plan arrangements, always with one or more yards for the collection of manure.

Linear plans

The farmhouse and working buildings are attached and in-line or arranged in an L-plan. This plan type includes medieval longhouses and the small 18th or 19th century farmsteads of often part-time farmers employed in local industries which are now most common in northern and western pastoral areas.

Table 3 How on-farm functions are expressed in farmstead fabric and areas	
Crop storage and processing	
<i>Key function</i>	<i>Spatial Requirement</i>
Storing the harvested corn in dark and well-ventilated conditions. Processing the corn into grain, through threshing and winnowing.	Corn was stacked in the <i>barn</i> , and sometimes in a stack yard next to the barn as well. Barns have: <ul style="list-style-type: none"> • large open spaces to the storage and threshing areas • wide doors to threshing floors where the corn was beaten from the crop • other openings for ventilation or pitching-in the crop Barns may also have evidence for horse, water and steam power. <i>Threshing barns</i> were built solely for the storage and processing of the harvested crop. One or two-storey <i>combination barns</i> combine these functions with others (eg cattle housing, stabling, cartsheds) and so have many more openings and can be floored. Split-level <i>mixing barns</i> developed from the later 18 th century as a result of the widespread introduction of machinery for processing corn and fodder.
Keeping grain clean, dry and secure from rodents and pilferers.	<i>Granaries</i> could be: <ul style="list-style-type: none"> • detached structures, placed above the ground; • or located in the loft of the house, above the stable or cartshed, or within a combination barn
Storing and processing specialist crops such as apples and hops	<ul style="list-style-type: none"> • oast houses, cider houses, malt houses
Shelter and Housing for Animals	
<i>Key function</i>	<i>Spatial Requirement</i>
Managing and accommodating cattle	Yards, sometimes sub-divided for different types of stock Shelter or housing, usually facing onto yard areas, which are: <ul style="list-style-type: none"> • open-fronted shelter sheds • small cubicles (looseboxes) with doors for intensive fattening or for bulls • cowhouses with stalls, and with access for both the cattle and in some cases passages for feeding and mucking out • large cattle sheds or covered yards Interiors to cattle housing could be quite dark with slits providing ventilation, proper lighting being more commonly introduced in the 19 th century.
Stalling horses	Stables were generally well-lit and ventilated buildings, with typically tall and more narrow doors than to cowhouses.
Housing other animals such as pigs, poultry and doves	Pigsties, dovecotes, henhouses, goose pens. Nesting boxes for doves, within dovecotes or incorporated into the exterior walls of farm buildings.
Storage and Processing of Animal Fodder	Hay needed to be kept dry and well-ventilated, and was commonly stored in lofts above stables or cattle housing. Some farms needed hay barns. Rooms for mixing and preparing fodder adjoined cattle housing – at one end or from the mid 19 th century as a mixing barn.
Vehicles	
<i>Key function</i>	<i>Spatial requirement</i>
Sheltering carts, wagons and implements	Cart sheds for carts and implements are open-fronted with lock-ups for implements. They typically face away from the cattle yard and often onto an access point or track.

4.0 DATA REQUIREMENTS

4.1 Ordnance Survey mapping

Historic mapping

Farmsteads mapping focuses on recording the farmstead plan as recorded in the late 19th century. The early mapping projects tested a variety of historic OS mapping including 1st Edition 6" and 1st Edition 25" mapping but the 2nd Edition 25" mapping dating from c.1895-1900 proved to be the most useful as this edition cross-hatches the buildings and also provides other useful information that assists with the interpretation of the plan such as the dotted lines indicating that a building was open-fronted. Whilst the 2nd Edition 25" does not offer the earliest set of detailed mapping consistently available across the country, it is of a date that shows farmsteads at the close of the period of traditional farm buildings – there was relatively little change from the end of the 19th century until after the First World War at which time there was an increasing use of mass-produced buildings that do not relate to local character.

Modern mapping

The modern OS Mastermap is compared to the 2nd Edition 25" in order to assess and record the degree of change a particular farmstead has experienced (see Section 7.2 and 7.3).

4.2 Historic Building Data

Gaining an understanding of the time-depth that may be evident in the standing buildings is an important element in relating the character of farmsteads to the landscape and historic landscape character. Dating is generally based on the presence of one or more listed buildings. It is acknowledged that the *List of Buildings of Special Architectural or Historic Interest* is an imperfect data set, particularly in relation to the dating of buildings where there may have been limited access to the interiors of buildings where earlier cores have been obscured by later changes.

However, the experience of the mapping of farmsteads to date indicates that using the listed building data set can illustrate correlations between farmsteads and landscape. Where there are local data sets that can provide further information on the date of farm buildings; either refining the dating of listed buildings or providing date information for unlisted buildings, this should be used.

4.3 Address Point Data

Address Point data is useful, not only for recording the present-day name of a farmstead but it can also be used to help in the identification of farmsteads if properties that incorporate the name 'Farm' are selected from the data. This can be particularly useful for small farmsteads which may not be so apparent from mapping alone.

Historic Environment Record Data

It may be useful to have Historic Environment Record Data available to add additional information to farmsteads records. Records of particular interest may relate to the presence of moated sites and deserted or shrunken settlements.

4.4 Aerial Photography

Experience in Shropshire has shown that vertical aerial photography is helpful for clarifying the plan type and degree of change a farmstead may have experienced. Many local authorities now hold digital aerial photography for use in their GIS systems. Alternatively, digital aerial photography is freely accessible on the internet via Google Maps (<http://maps.google.co.uk>) and Microsoft's Live Search (<http://maps.live.com/>).

5.0 MAPPING FARMSTEADS

5.1 *Farmsteads, Small-holdings Outfarms and Field Barns*

When mapping it is important to distinguish between farmsteads, defined by the presence of the farmhouse, or detached locations comprising field barns and outfarms away from the farmstead - either as a single building or in a group. It should be noted that some outfarm complexes were accompanied by a cottage or cottages for farm labourers who looked after the stock. Despite the presence of housing, such sites should be recorded as Outfarms.

In some landscapes the presence of outfarms or field barns can make a major contribution to the character of the landscape. In other landscapes outfarms may not be prominent features, either because of a low density of sites or the subsequent loss of sites, but still represent the agricultural development of the landscape.

In some areas, particularly where farming was combined with industrial activities, small-holdings were common. These sites may not have conventional farmstead plans but are characteristic elements of the landscape and should be included within the farmstead mapping.

5.2 *Farmstead Date*

Using historic building data the earliest date of any recorded standing building is used to give the Farmstead Date. Whilst the key periods for farmstead development do not follow century periods, the century is used for Farmstead Date as listed building data often gives the date as a century. Due to the relatively small numbers of medieval farm buildings, 'Pre-1600' is used for all farmsteads with a building dating from before that date.

The mapping projects completed to date have only recorded the earliest date

assigned to any listed building within the farmstead without recording whether the date was derived from the farmhouse or from an agricultural building. In certain landscapes there may have been high levels of change within the working buildings whilst older houses survive, often in an altered form. For future projects it is recommended that the dating information recorded is more specific through the use of two Date fields:

DATE_HM (House or map evidence)

DATE_WB (Working building)

Where a farmstead has a dated house and dated farm buildings both can be recorded which will allow future analyses to exclude farmhouses if required.

5.3 *Farmstead Plan*

The farmstead plan results from the arrangement of buildings around open spaces (yards, gardens etc) and access points. Observation of the plan will show how domestic and working buildings face towards or away from:

- **access** to the farmstead, distinguishing between public and private access. Some farmsteads may only have a single, private point of access, which constrains the volume of movement to and from the site, whilst others may stand alongside or sit astride a road or public path or be at a junction of routeways giving public access to the centre of the farmstead.
- **working spaces** within and around the farmstead. Working spaces are open areas within and around the farmstead which functioned for stacking crops and moving livestock and vehicles. Working spaces on the perimeter of a farmstead, including those for stacking corn and other small enclosures, serve to link the outer

edges of the farmstead to its surrounding landscape.

- **yards.** These are areas for containing livestock, particularly cattle, onto which buildings (especially shelter sheds and other stock buildings) face. Single or multiple yards are of fundamental importance to the development of many farmsteads and can range from fully enclosed, private spaces surrounded by buildings to more open yards served by one or two buildings. Some farmsteads, especially those that are dispersed in their form, are not focused on any single yard area but may have several yards relating to individual buildings or groups of buildings.

Gardens can stand within or to one side of the farmstead, and historically developed as private areas with a distinct and separate character. They may be screened from the working areas of the farm by hedges or walls.

5.4 How to Record Plan Type

It is vital when recording the plan to focus on the *dominant* character of the plan using the farmstead types defined in Table 2 and in Section 6 below. In essence, the methodology described here works by assigning an alphanumeric code to each farmstead which provides an abbreviated characterisation of the plan form and other relevant data. This is why the recording exercise provides a complete plan type code which distinguishes between primary and secondary attributes.

Primary Attributes

The Primary Attribute records the principal farmstead type as the main characteristic of the farmstead plan: whether it is a Loose Courtyard, Regular Courtyard, Dispersed, Linear, L-Plan with attached house or Parallel.

Secondary Attributes

Within each of the basic forms of farmstead plan recorded as the Primary Attribute there can be a number of sub-types which reflect the variations in plan form. For example, Loose Courtyard plans may have 1, 2, 3 or 4 working buildings facing into the yard, the number forming the secondary attribute.

Tertiary Attributes

The Tertiary Attribute uses the same set of codes as used in the Secondary Attribute field and allows the recording of other subsidiary element(s) of the farmstead plan which are worth recording but not dominant enough to be regarded as the Secondary Attribute. For example, a Regular Courtyard E-plan (RCe) may have one of the yards covered which can be recorded as the Tertiary Attribute.

Farmstead Attribute Table

PRN	Unique No.	Numeric sequence chosen to fit with any existing data set PRNs
Site Name	Modern Name (historic name)	Modern farm name with historic name (if different) recorded in brackets
Classification Primary Attribute	FARMSTEAD OUTFARM	Farmstead with house Outfarm or field barn
Classification Secondary Attribute	HOME MAN MILL PUB RECT	Farmstead identified as a Home Farm of an estate Farm Buildings associated with a Manor Farm Buildings associated with a Mill Farm Buildings associated with a Public House Farm Buildings associated with a Rectory
Date_HM (Date of House based on presence of dated building or Map evidence)	MED C17 C18 C19L C19	Pre 1600 17 th century 18 th century 19 th century (based on presence of a listed building dated to 19 th century) 19 th century (based on presence on historic map)
Date_WB (Date of Working Building based on presence of dated building)	MED C17 C18 C19L	Pre 1600 17 th century 18 th century 19 th century (based on presence of a listed building dated to 19 th century)
Plan Type		Combination of Primary and Secondary Plan Attributes e.g. LC3; RCe etc. (see below)
Plan Type Primary Attribute	DISP LC LIN LP PAR RC ROW UNC	Dispersed Loose Courtyard Linear L-plan (attached house) Parallel Regular Courtyard Row Plan Uncertain
Plan Type Secondary Attribute	1, 2, 3, 4 L3 or L4 L u e f h t z cl dw my cov d y	No. of sides to loose courtyard formed by <i>working</i> agricultural buildings Yard with an L-plan range plus detached buildings to the third and/or fourth side of the yard (may be used with LC or RC dependent on overall character) Regular Courtyard L-plan (detached house) Regular Courtyard U-plan Regular Courtyard E-plan Regular Courtyard F-plan Regular Courtyard H-plan Regular Courtyard T-plan Regular Courtyard Z-plan Cluster (Used with DISP) Driftway (Used with DISP) Multi-yard (Used with DISP or RC) Covered yard forms an element of farmstead Additional detached elements to main plan Presence of small second yard with one main yard evident
Tertiary Attribute		Codes as per Secondary Attribute table e.g. cov or combination of Primary and Secondary Attributes e.g RCL notes presence of a prominent Regular L-plan within a dispersed multi-yard group

Farmhouse Position	ATT LONG GAB DET ATT DET UNC	Attached to agricultural range Detached, side on to yard Detached, gable on to yard Farmhouse set away from yard Attached to agricultural range, central position Detached farmhouse, central position Uncertain (cannot identify which is farmhouse)
Location Primary Attribute	VILL HAM FC ISO PARK SMV CM URB	Village location Hamlet Loose farmstead cluster Isolated position Located within a park Shrunken village site Church and Manor Farm group (or other high status farmstead) Urban
Survival	EXT ALT ALTS DEM HOUS LOST	Extant – no apparent alteration Partial Loss – less than 50% change Significant Loss – more than 50% alteration Total Change – Farmstead survives but complete alteration to plan Farmhouse only survives Farmstead/Outfarm totally demolished
Sheds	SITE SIDE	Large modern sheds on site of historic farmstead – may have destroyed historic buildings or may obscure them Large modern sheds to side of historic farmstead – suggests farmstead probably still in agricultural use
HER Record	UID	Cross reference to existing HER number
Converted buildings?	Yes/No	Note presence of converted buildings based on address point data
Confidence	H M L	High Medium Low
Notes		Free text field to add notes relating to the character or identification of a record

6.0 DESCRIPTION OF PLAN TYPES

6.1 Loose Courtyard Plans

Primary Attribute	Secondary Attribute
LC	1
	2
	3
	4
	L3
	L4

There are two defining characteristics required in the identification of a Loose Courtyard Plan:

- the presence of an area that can be defined as a yard;
- detached farm buildings grouped around the yard.

Loose Courtyard Plans are often the product of piecemeal development and can range from small farmsteads with a single building on one side of the yard and the farmhouse (LC1) to a yard defined by working buildings to all four sides (LC4) (Figures 1 – 4 and 6).

Typically the buildings around the yard face into the yard and have few, if any openings in the external elevations. The farmhouse may also face into the yard, be set gable end on to the yard or set to one side.

The size and function of the yard area may differ in different parts of the country. In arable and mixed farming areas the yard served as a stock yard where cattle would be over-wintered and their manure collected and stored. In cattle rearing and dairying areas, the yard may be both much smaller and serve more as a general circulation and access area to cattle housing, lofts, the house, dairy and other buildings.

Tertiary elements such as cartsheds and some other ancillary buildings may stand outside the yard area and be aligned to routes and tracks.

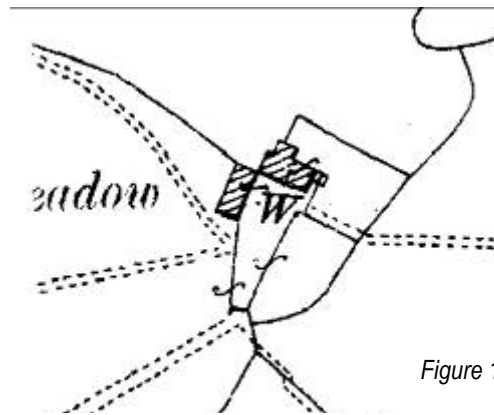

Figure 1

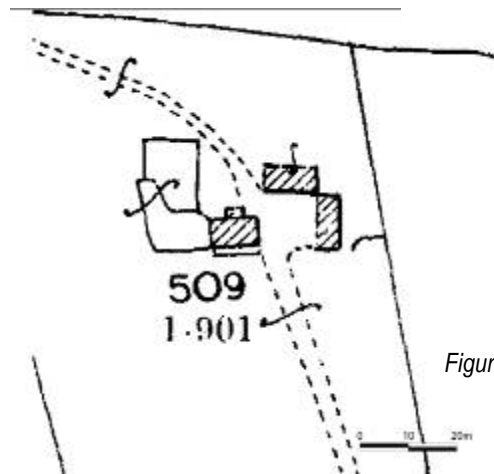

Figure 2

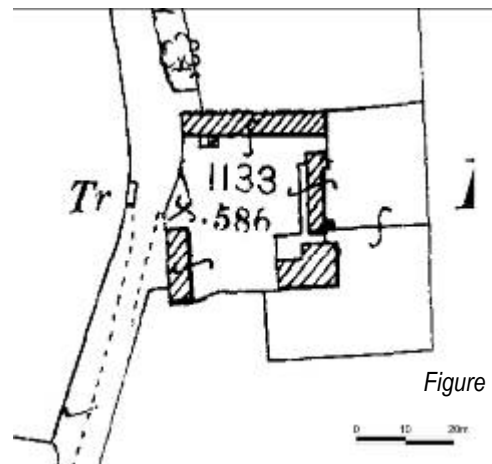

Figure 3

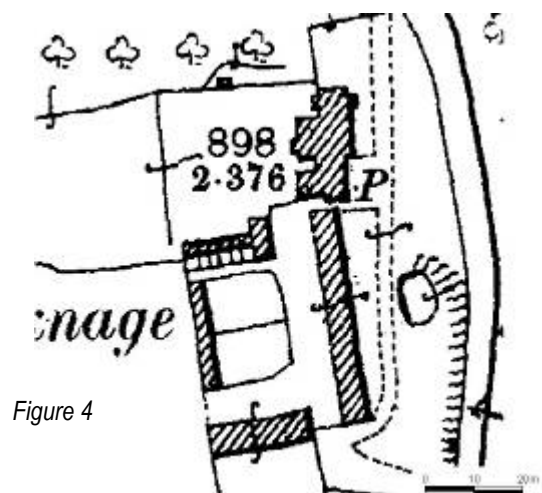

Figure 4

Some farmstead plans appear to combine a Regular L-plan element and detached buildings around a yard (Figure 5). Such a plan may originate from a loose courtyard with the L-plan element being the result of, for example, a shelter shed being added to an earlier barn. Alternatively, the L-plan range may be of a single build and have the characteristics of a Regular Courtyard L-plan with some additional detached buildings. Often it is not possible to be certain of the overall character from the map evidence – loose courtyard or regular courtyard. The decision to use LCL3/4 or RCL3/4 may be dependent upon the general character of farmsteads in the area being mapped; whether regular L-plan ranges are a dominant characteristic or loose courtyards are the most common plan type. Some field checking will be important to inform this decision.

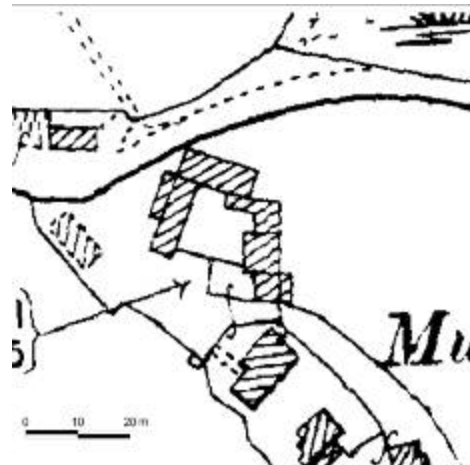

Figure 5

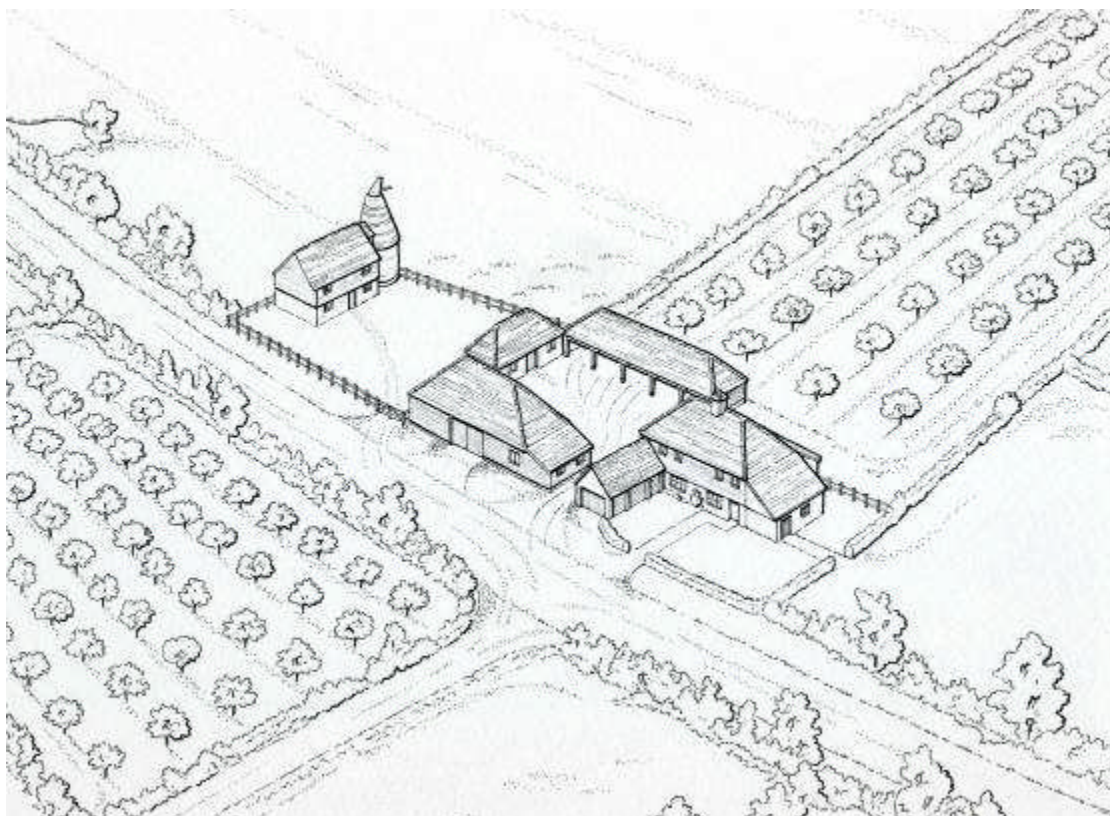

Figure 6 A Loose Courtyard plan with working buildings to 3 sides of the yard and the farmhouse gable end to the yard

6.2 Regular Courtyard Plans (RC)

Primary Attribute	Secondary Attribute
RC	-*
	L
	u
	e
	f
	t
	h
	z
	my
	cov
	L3
	L4

* A full Regular Courtyard plan may have no Secondary Attribute

The defining characteristics of Regular Courtyard plans are:

- a planned or regular appearance;
- buildings focused around one or more yards;
- linked ranges of buildings lining the yard(s), offering a variety of layouts.

Regular Courtyard plans are those where there are generally linked ranges of buildings ranged around one or more yard areas. Regular Courtyards can range from the large architect designed model farms of the great estates to small L-plan ranges found on some relatively small farmsteads.

Regular Courtyard plans often represent a single phase of development and are predominantly of 19th century date. Even where they of more than one phase, Regular Courtyards often display greater consistency in the use of materials and may utilise non-local materials such as Welsh slate. They can be strongly concentrated in landscapes enclosed or re-planned in the 18th and 19th centuries.

Regular Courtyard plans can vary in their character in terms of the treatment of the external elevations (Figures 7, 8 and 9). In some (especially arable and mixed farming) areas external elevations are

almost entirely blank except perhaps for a cartshed facing outwards onto an access route. In other areas, typically where pastoral farming was predominant and where multi-functional ranges are common, the external elevations may include numerous openings.

The farmhouse can face into the yard, sometimes being attached to one of the farm building ranges, be set gable-end on to the yard or be detached from the yard set in its own grounds and with a separate access.



Figures 7 and 8 Two sides of a small L-plan range in west Staffordshire with numerous openings to both elevations of the main range

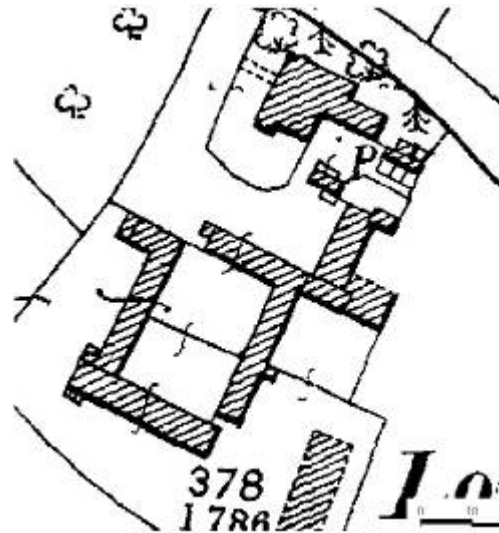

Figure 9 A Regular Courtyard farmstead in Devon with linhays (two storey open-fronted shelter sheds with haylofts above) which has no openings in the external elevations.

Full Regular Courtyards

The term Full Regular Courtyard (RC) records those farmsteads where the yard is enclosed on all four sides by linked ranges. Some Regular Courtyards will have only one small entry to the yard. Many Regular Courtyards will have two or more entrances or openings, for example, where there are two opposed L-plan ranges (Figure 11). The term is also used to include farmsteads where there is a mixture of linked ranges and detached buildings but the overall character is one of considerable regularity and the impression of planning (Figure 12). This will include some of the largest home farms of large estates (Figure 13).

Figure 11, below



The key characteristics are the predominance of linked ranges, enclosure to all four sides of the yard and regularity in the layout. On larger estate farms the farmhouse is typically set to one side of the yard (although workers cottages may form part of the planned layout) but in some smaller examples the farmhouse can be linked to one of the ranges.

Figure 12, below

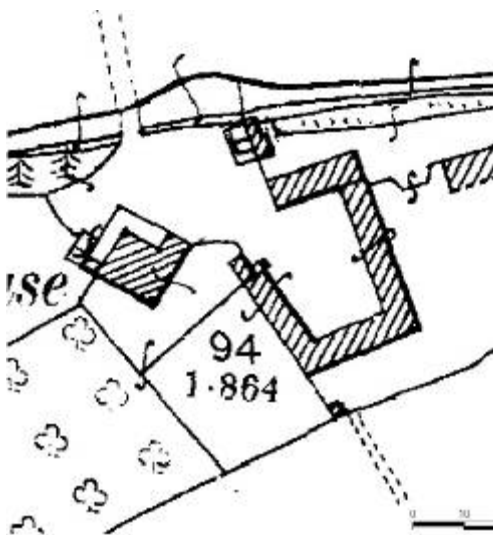
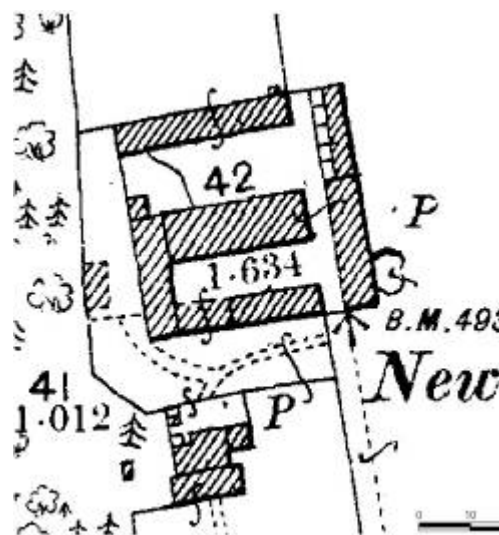
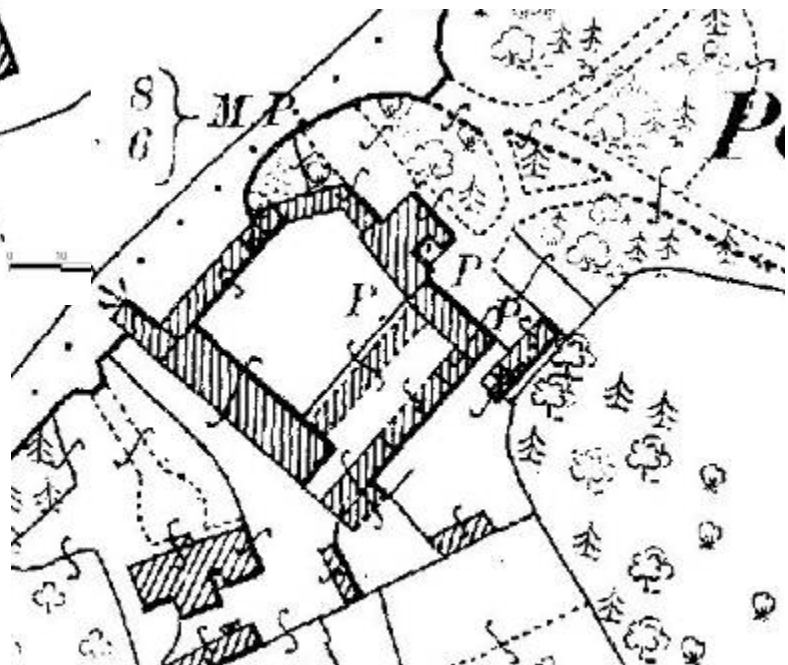

Figure 10

Figure 13, below



Regular L-plans

Regular L-plans consist of two linked ranges set at right angles to create an L-shape (Figure 14). This typically creates a defined yard area. However, in some areas where the L-range consists of a multi-functional building all elevations can be active with doors and windows (Figures 7 and 8). Whilst the plan form will be similarly described, such differences in character will need to be identified from ground-checking.

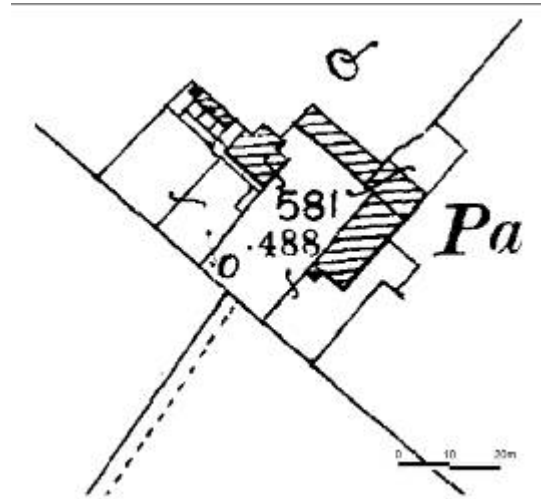

Figure 14

Whilst Regular Courtyards are predominantly the result of planning Regular L-plans, probably more than the other Regular Courtyard plans, can include farmsteads that have developed from a Loose Courtyard plan with the addition of a range at right angles to a pre-existing building, often a barn (Figures 15 and 16). Therefore, Regular L-plans are recorded in areas where either Loose Courtyard plans or Regular Courtyard plans are predominant. The origins and character of Regular L-plan farmsteads can be verified through rapid field survey.



Figure 15 (top) Regular Courtyard arrangements: Top a planned L-plan range on a Cheshire dairy farm providing cattle housing and stabling with fodder storage above.

Figure 16 (bottom) An L-plan range created when a shelter shed was added to an earlier threshing barn.

Figures 15 and 16

There are variations on the Regular L-plan that are observable in some areas including farmsteads where the L-plan element is accompanied by a range on the third side of the yard (Figure 17) and, sometimes, also on the fourth side. Such plans are recorded as RCL3 or RCL4 plans (see also p.11, above).

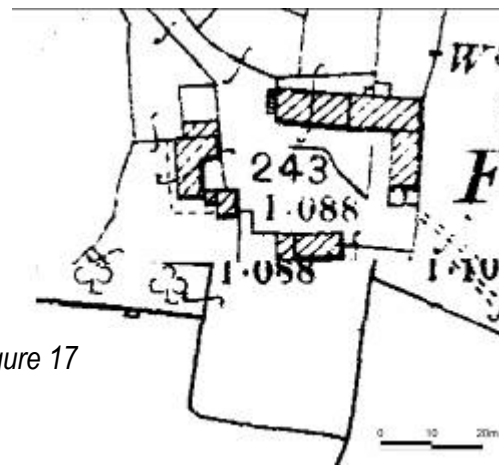

Figure 17

Regular U-plans

Regular U-plans typically represent medium-sized farmsteads built by large landowners and estates on tenanted farms. They have linked ranges to three sides of the yard (Figures 18 and 21) although a U-range broken by a small entrance in the centre of the central side would probably also be considered as a U-plan providing there is sufficient regularity.

U-plan farmsteads are typically inward facing but in some areas the openings are also found in external elevations. Figures 19 and 20 show the same Staffordshire farmstead depicted in Figure 18 – the west and south elevations are typical of most U-plan farmsteads in that the only external openings are an entrance driftway in the west range, pitching doors for unloading hay and small ventilation holes. However, the north range (Figure 20) consists of a series of windows to animal housing at ground floor level with doors to a hayloft at first floor level.

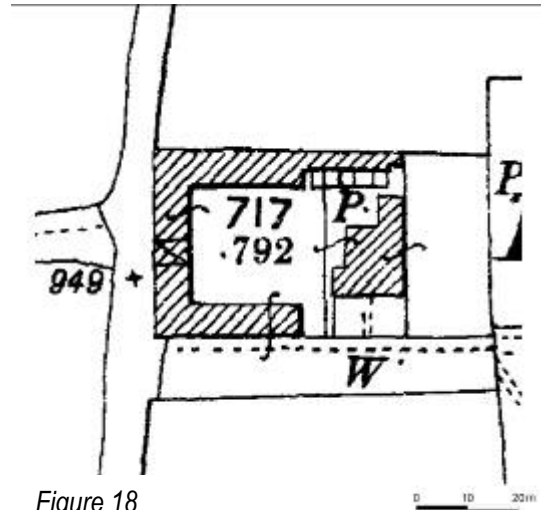
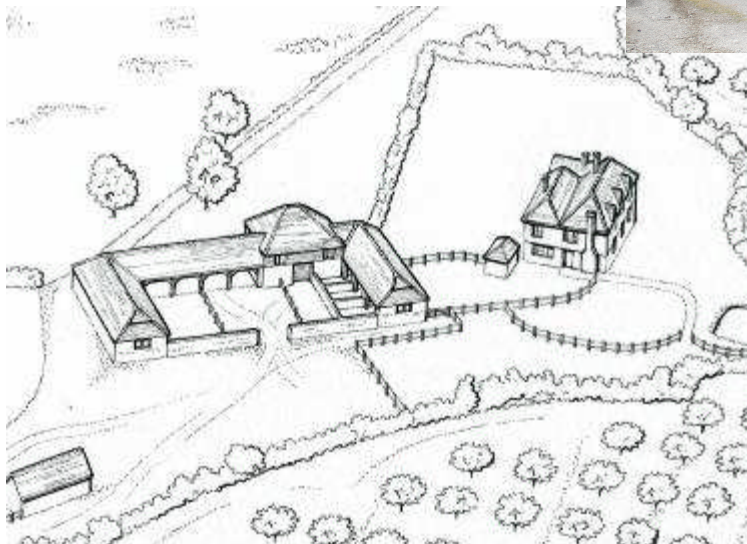

Figure 18



Figures 19 and 20

Figure 21



Regular E-, F-, T-, H- and Z-plans

This group of plan types, typically representing farmsteads built by large landowners and estates, will incorporate more than one yard area. Many of these plans will incorporate a range of functions including threshing barns, hay and fodder storage areas, cattle housing, stables and cart sheds. Accordingly, some of these building ranges are multi-faceted buildings with openings to all or most elevations.

The form of these plans is adequately described by the letters used except perhaps for the Z-plan which consists of at least three ranges; a central range with ranges at each end set at right angles to either side of the central range.

The typical E-plan will be a two-yard plan defined by three short ranges extending from a longer range (effectively a double U-plan) (Figure 22). Figure 23 shows a farmstead with a detached central arm; this plan would also be regarded as an E-plan. Examples that have three yards defined by four short ranges would also be considered as an E-plan with a note to record the extra yard.

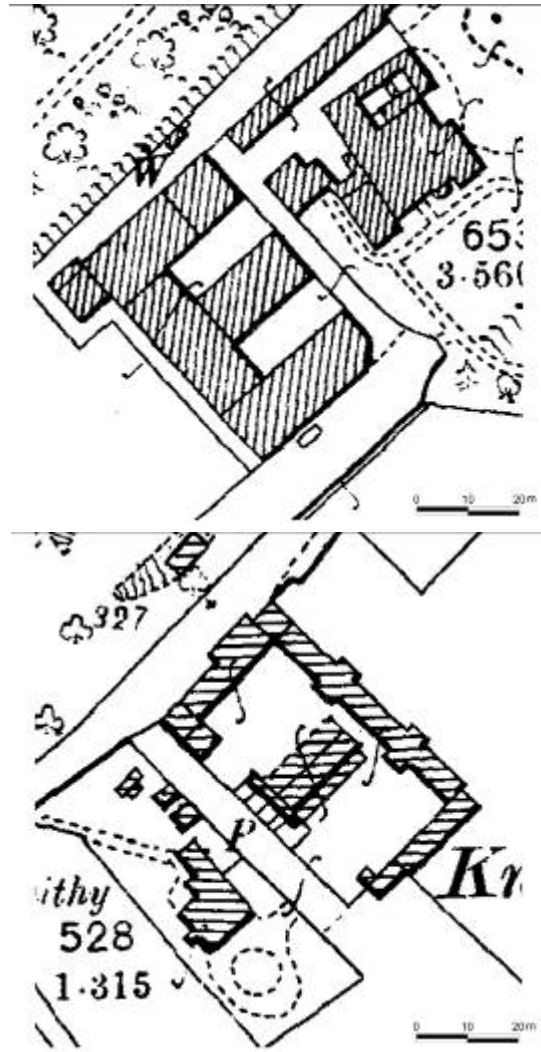

Figures 22 and 23 Examples of E-plan farmsteads



Figures 24 and 25 (right)
Two E-plan farmsteads.: Top Cambridgeshire;
Bottom Staffordshire. The Staffordshire
example illustrates an architect designed
regular courtyard farmstead on an estate, in
this case one of three of the same type within
view of each other.



Regular F-plans are similar to the E-plan except that there are only two short ranges extending from the principal range (Figures 26 and 27).

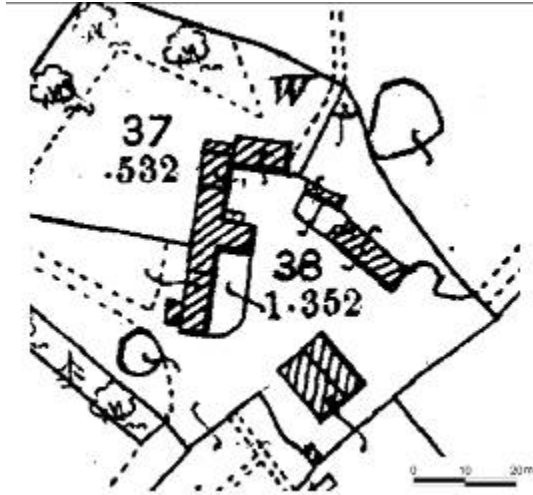

Figure 26

Regular T-plans consist of two ranges set at right angles to each other with one joining the second range at approximately mid-way along its long side Figure 28. Typically this forms two yards or working areas either side of the stem of 'T'.

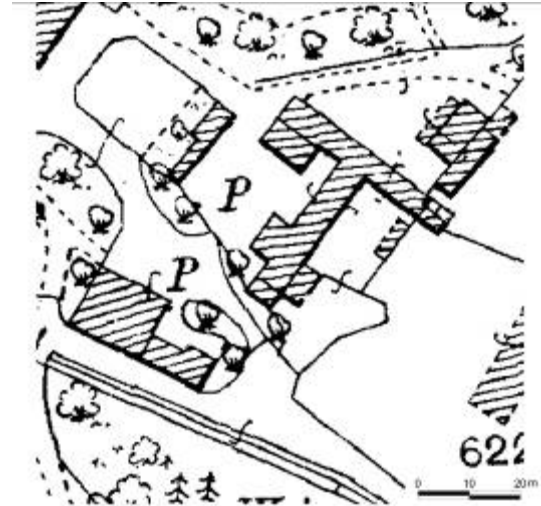

Figure 28

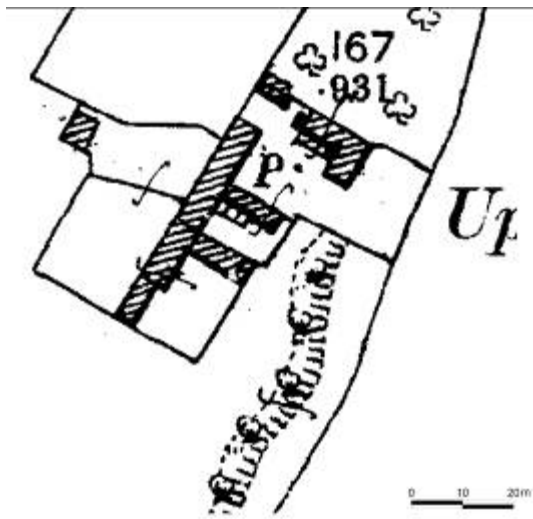

Figure 27

Regular H-plans represent a further stage from the T-plan yard in having a third range at right angles to the stem of the 'T'. These plans can alternatively be seen as back-to-back U-plans (Figure 29).

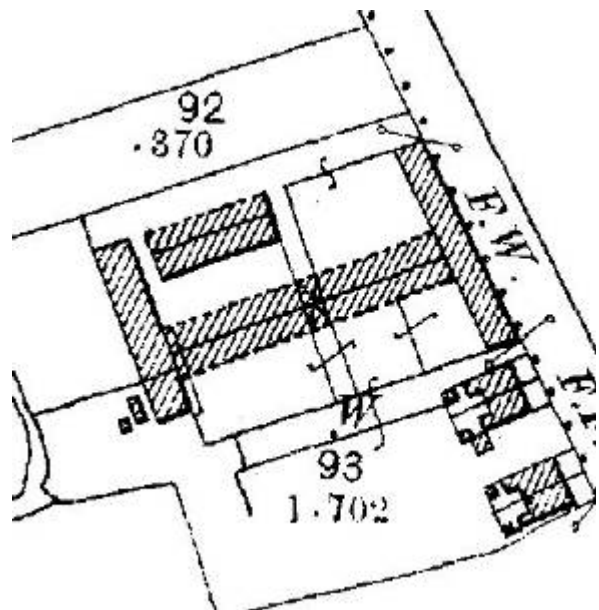

Figure 29

Regular Multi-yard Plans

When initially identified Regular Multi-yard plans were classified with the Dispersed plan types – the plan type was seen as being a more regular version of the Dispersed Multi-yard. However, the distribution of this plan type, for examples as seen in Staffordshire, reflects the pattern of Regular Courtyard plan types.

Regular Multi-yard plans represent farmsteads that have more than one principal yard area, the key characteristic

being the *regular arrangement of yard areas* in relation to one another (Figures 30 and 31). Usually they will be attached or divided from each other by buildings serving the yards to one or both sides. In contrast, Dispersed Multi-yard plans have more than one yard which are detached from each other and have no clear indication of a planned arrangement (see p.22, below) and are frequently of a large scale.

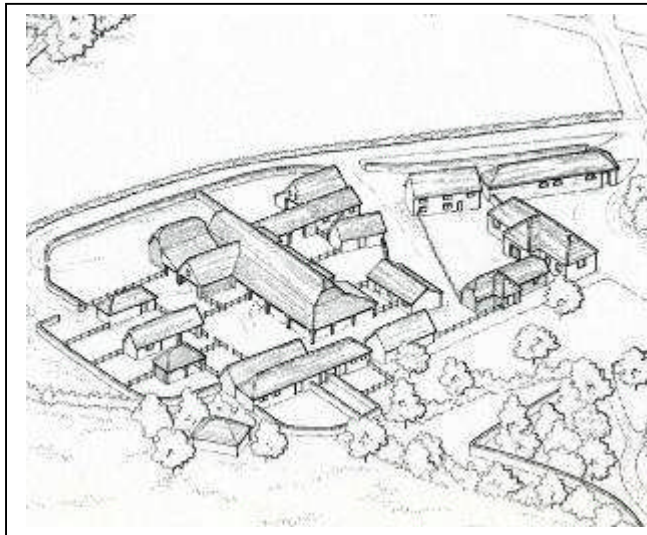

Figure 30

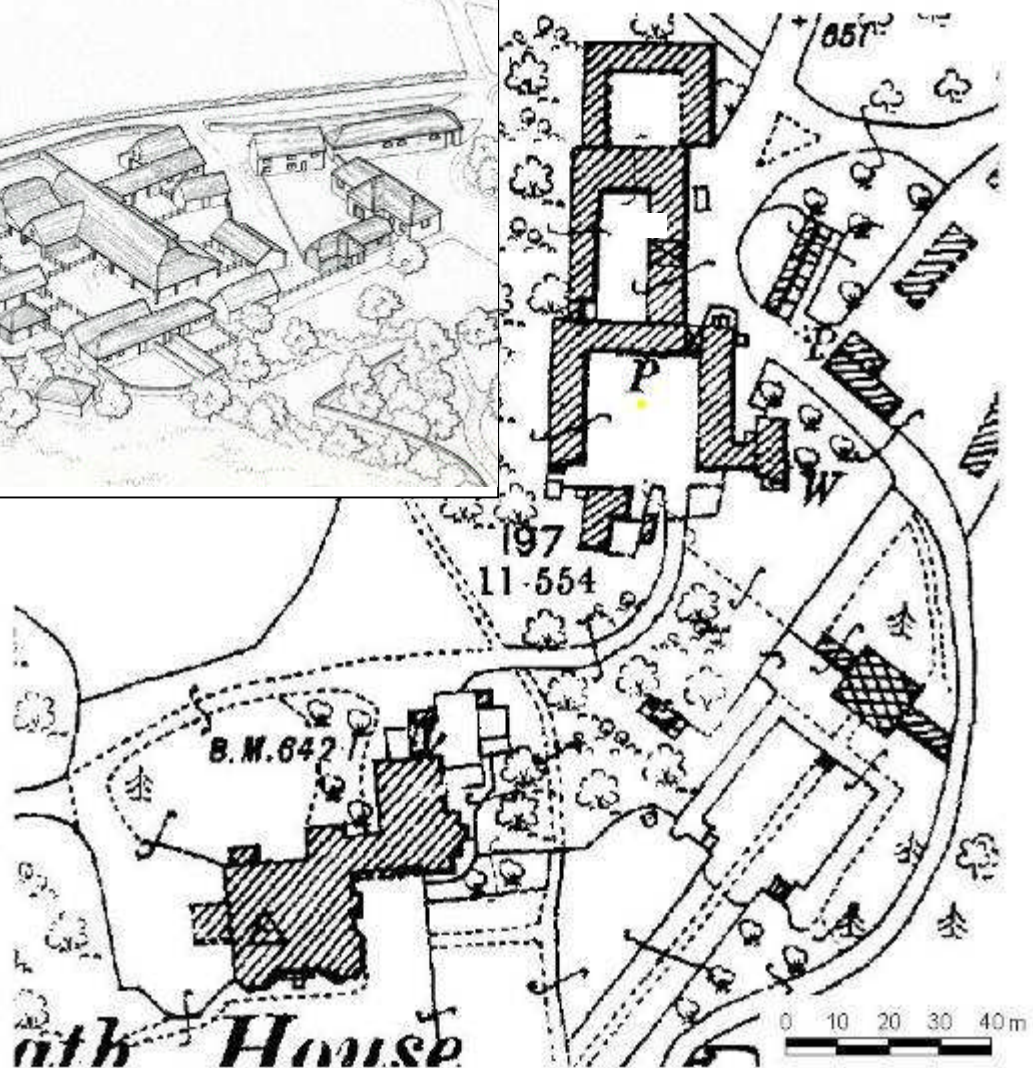

Figure 31

Covered Yards

Covered yards were a development of the mid-19th century, as a result of realisation that the quality of manure was best preserved through protection from the elements – typically in combination with good housing for stock, particularly where fattening was carried out. There are two methods of providing a covered area for cattle, both of which have historically been described as covered yards:

- the covering of a yard area defined in part by buildings (Figure 34). The covered yard may be part of the original design of the farmstead or the later covering of the fold yard;
- a purpose-built wide-span building within which cattle could be housed either tethered or loose, the interior of which could be sub-divided to create loose-boxes (Figures 32, 33 and 35).



Figures 32 and 33 Purpose-built covered yard buildings

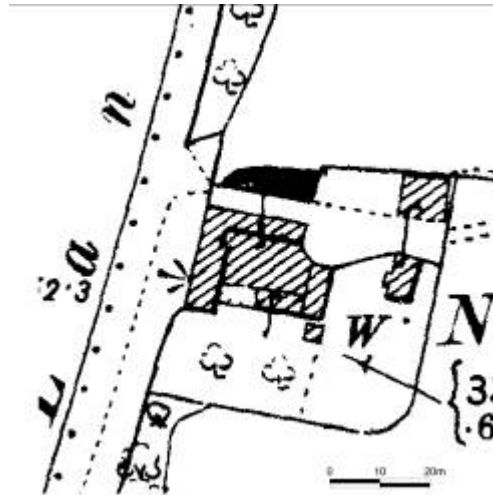

Figure 34



Figure 35

6.3 Dispersed Plans

Primary Attribute	Secondary Attribute
DISP	cl (Cluster)
	my (Multi-yard)
	dw (Driftway)

These range greatly in size, and include farmsteads in hamlets where the buildings of different farms can be intermixed. They are most strongly concentrated in landscapes of ancient enclosure, and in particular where cattle rearing – and the need for separate contained areas for livestock – was historically important.

Typical features are:

- buildings or groups of buildings set within a general area, but there is not a principal yard area that provides a focus for the whole group
- buildings present many facets to the surrounding landscapes
- dispersed plans are often dissected by public rights of way which provide access into the heart of the farmstead.

The understanding of Dispersed Plans has developed as a result of the farmstead mapping projects, particularly through the recording of farmsteads in the High Weald of Kent and Sussex where farmsteads that were dispersed in character but with particular elements and features that set them apart were noted. There are three Dispersed Plan types; Clusters, Multi-yard plans and Driftway plans. All of these plan types can be closely associated with routeways which can result in public access into the very heart of the farmstead in a way that is extremely rare in relation to the Loose Courtyard or Regular Courtyard plan types.

Dispersed Cluster Plans (cl)

The defining characteristics of Dispersed Cluster Plans are:

- a farmstead group where there appears to be little or no attempt at planning in the arrangement of the steading (Figure 36)
- typically there is no defined yard that provides a focal point for the group
- If there is a yard present there will be a sufficient number of other dispersed buildings to mean that the yard is not the defining element of the group but is a Tertiary plan element (see Figures 37 and 38).

Dispersed Cluster farmsteads are most closely associated with small farmsteads, often associated with communing, where there were few buildings and animals and so careful planning in the layout for labour saving was of little importance. However, in some parts of the country there are larger examples of Dispersed Cluster farmsteads that can have many buildings scattered over a large area (Figures 36, 37 and 38).

Some larger Dispersed Cluster farmsteads were re-organised in the 19th century, often utilising an earlier building such as a barn for the focus a new yard with new buildings added to the other sides of the yard.

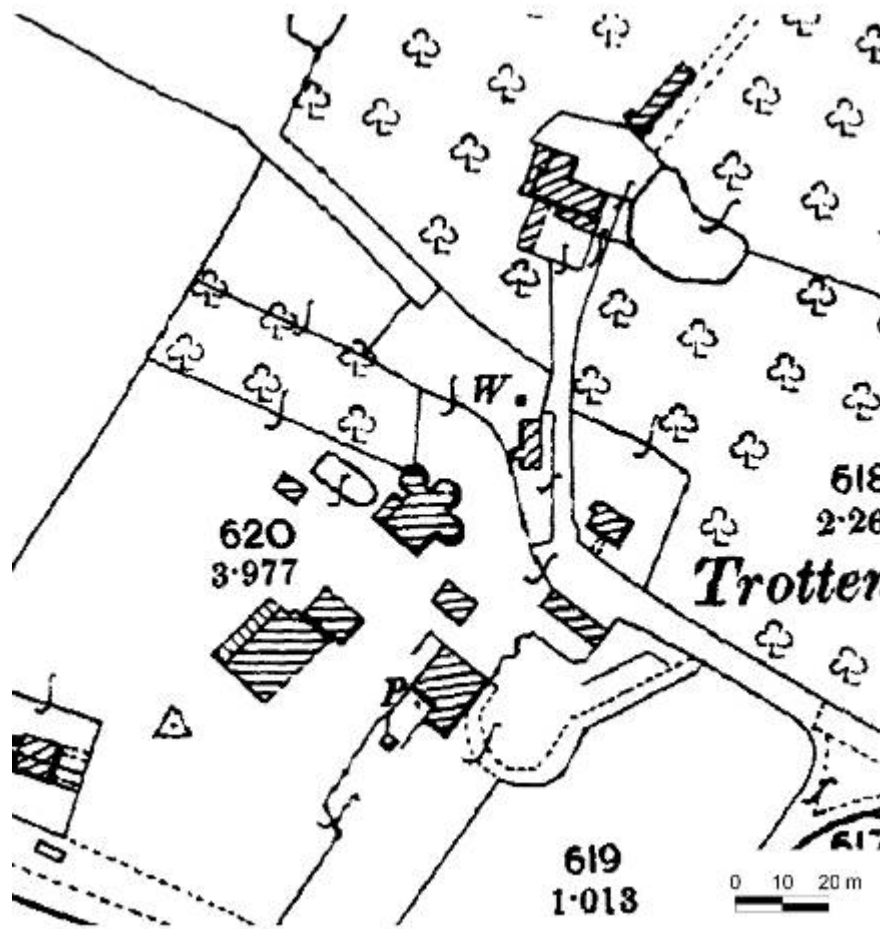

Figure 36

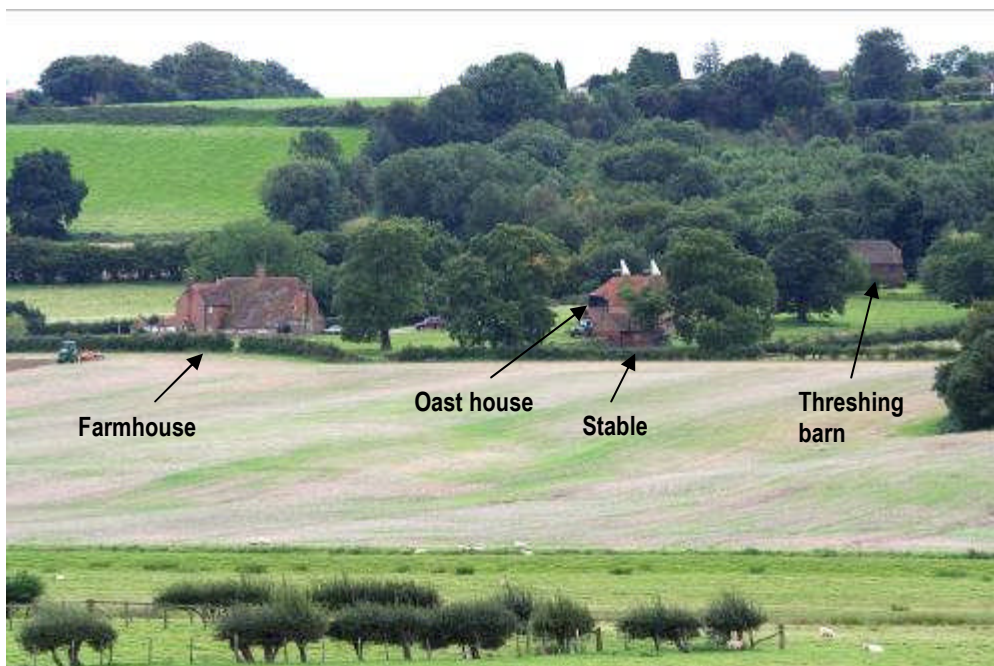

Figure 37 Dispersed cluster farmstead showing the large area that the steading occupies

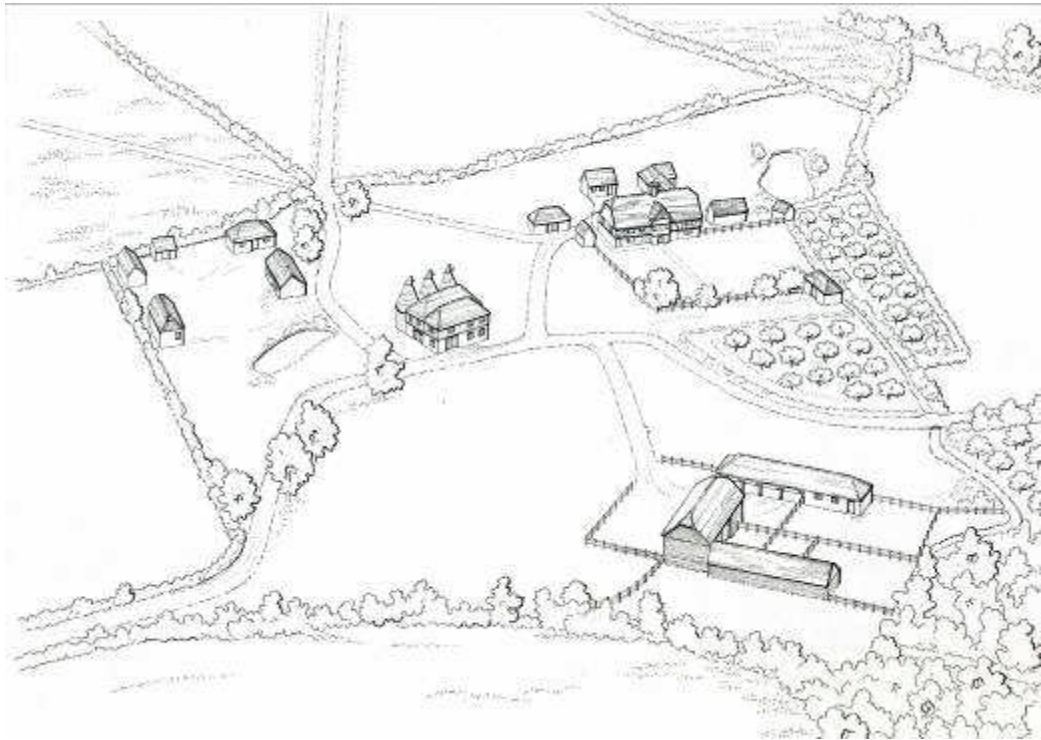

Figure 38 Dispersed Cluster. Although there is a yard area, the principal characteristic of the farmstead is the number of detached buildings set within the large paddock which is crossed by several footpaths. The yard area, here an LCL3 would be recorded as a Tertiary element

Dispersed Multi-yard Plans (my)

The defining characteristics of Dispersed Multi-Yard Plans are:

- Buildings relating to a number of yard areas, typically detached from another and often spaced over a relatively large area (Figures 39 and 40).
- often there is no yard that can be clearly identified as the principal yard area.

The yards can be small areas associated with a single building or can be associated with regular plan arrangement and there can be a mix of plans within a single farmstead.

Multi-yard plans appear to be typically associated with areas where stock rearing or fattening was the prime element of the agricultural economy, the various yards allowing for the segregation of animals of different ages etc.

Figure 39

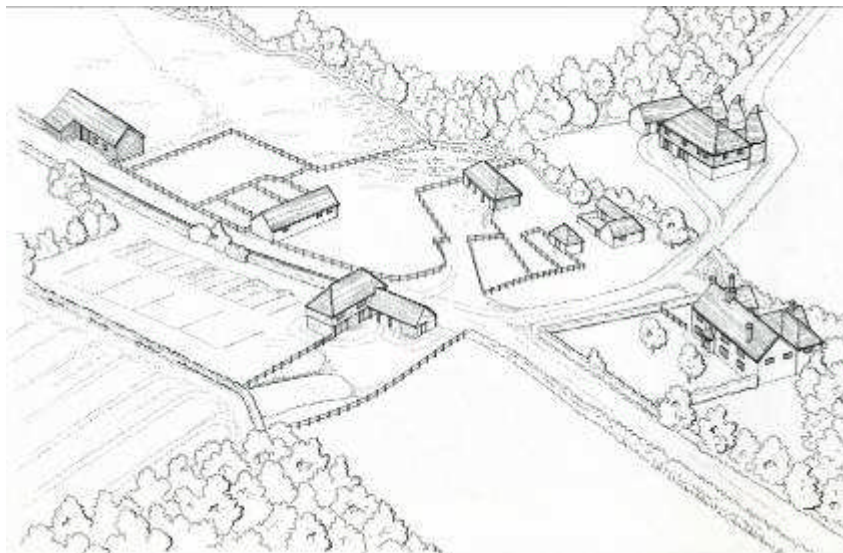
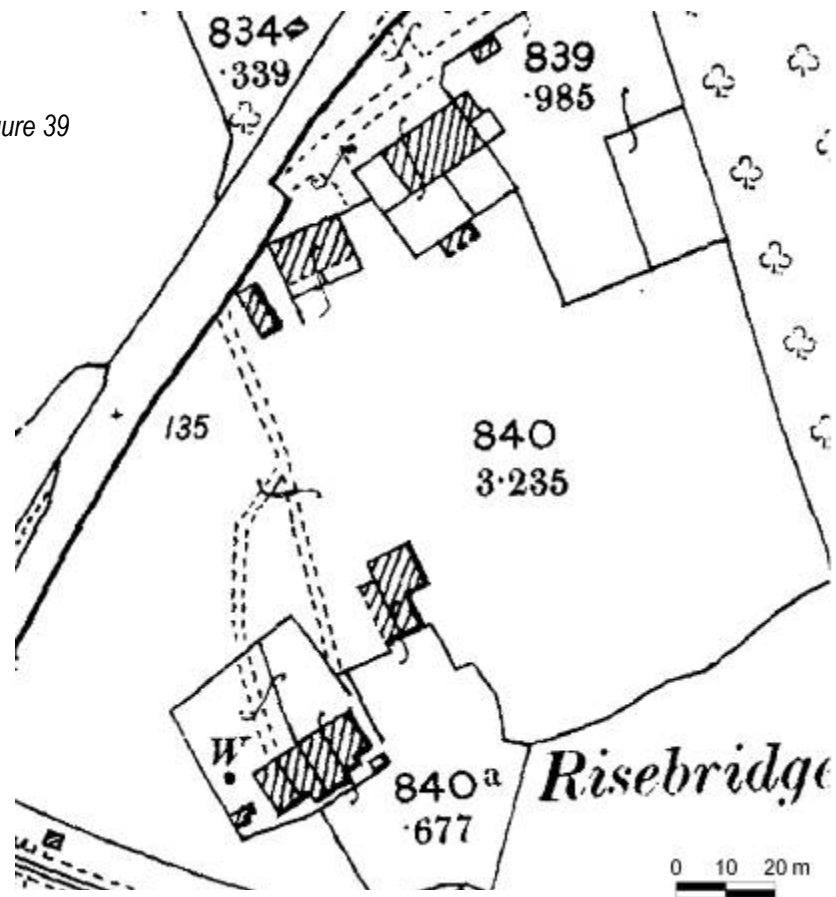

Figure 40

Dispersed Driftway Plans (dw)

The key characteristics of Dispersed Driftway Plans are:

- a routeway, often but not necessarily a public right of way that passes through the heart of the farmstead;
- detached buildings and/or yards alongside and sometimes within the width of the routeway (Figures 41 and 42)

In some cases the farmstead is strung along the sides of the driftway resulting in long, narrow arrangements. Dispersed Driftway Plans can incorporate one or more yard areas; the plan form of the largest of any yards can be recorded as a Tertiary plan element, for example, in Figure 41 the Tertiary element would be LCL3 (this farmstead is from an area where loose courtyards are predominant and the L-plan arrangement to the yard at the north almost certainly represents the addition of a shelter shed to an earlier barn). Other forms can be recorded in the Notes.

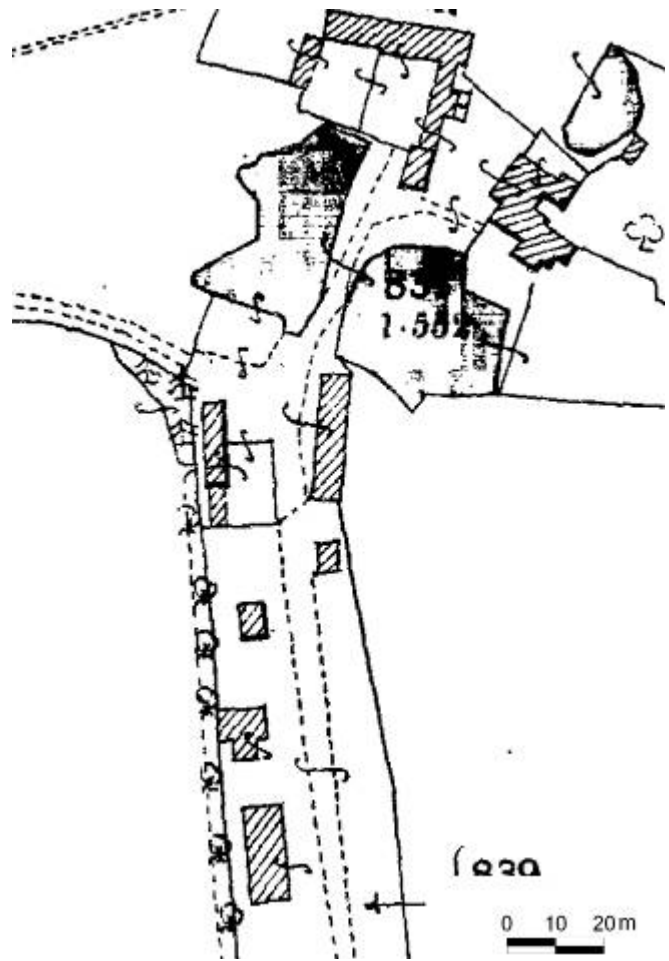
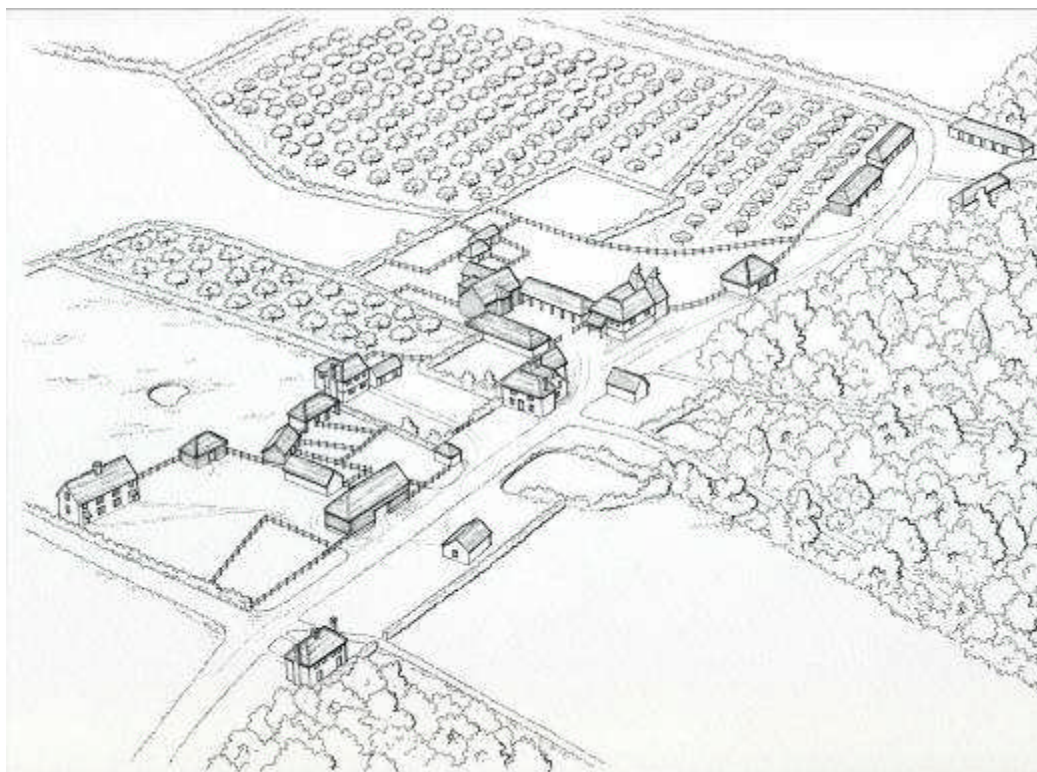

Figure 41 (above)

Figure 42 (below)



6.4 Small Plan Types

Linear and L-Plan (house attached) Plans

Primary Attribute	Secondary Attribute
LIN	-*
LP	-*

* There are rarely Secondary Attributes for these plan types. Small detached elements (d) can be recorded as Tertiary elements

In some parts of the country, mostly but not exclusively in upland areas, it was traditional to link the farmhouse and farm buildings. Linear and L-Plans with the house attached as part of the range display a wide range in scale and social status, from small farmsteads and often part-time farmers (who were also involved in industrial activities such as mining, quarrying or cloth-making) to larger and higher status farms. The medieval longhouse is the classic form of Linear Plan but they only survive as easily recognisable longhouses in certain parts of the country. In some areas longhouses have either undergone considerable alteration or replacement whilst in areas such as the south-east of England there is no evidence for a longhouse tradition and all Linear plan types are rare. The majority of Linear and L-Plan farmsteads are of eighteenth and nineteenth century date and may consist of a very small cottage with a byre for two or three cattle attached.

L-Plans with the house attached may represent incremental development of an earlier Linear Plan, a range built in a single phase or the development of a farmstead on the site of an earlier house (or the re-arrangement of a farmstead where the house was retained).

Linear and L-Plan (house attached) plan types are probably the most problematic of the plan types to identify from mapping in areas where the farmsteads are very small.

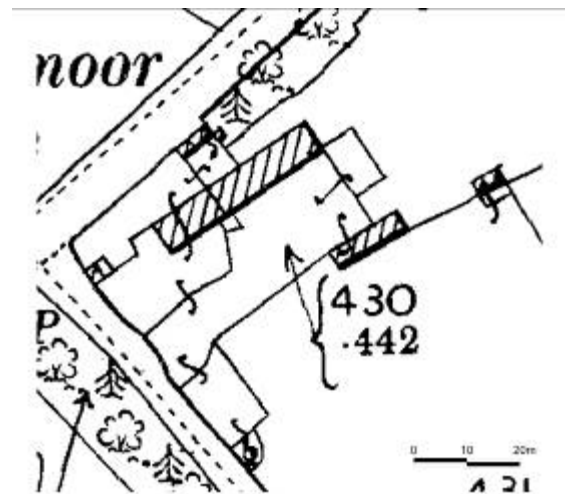

Figure 43

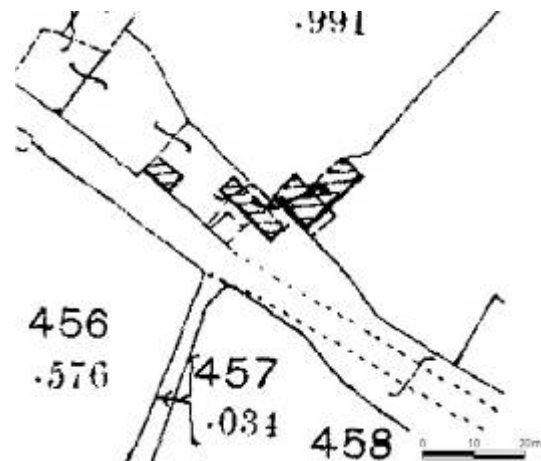

Figure 44

Figure 44 in particular demonstrates the difficulty of identifying very small Linear plan types. The two buildings are both Linear ranges incorporating cow houses attached to the house, the eastern cottage having the cattle housing under the same roof and are shown in Figure 45.



Figure 45



Figure 46 Small L-plan range with later farm buildings attached to the house (which has been re-faced with brick).

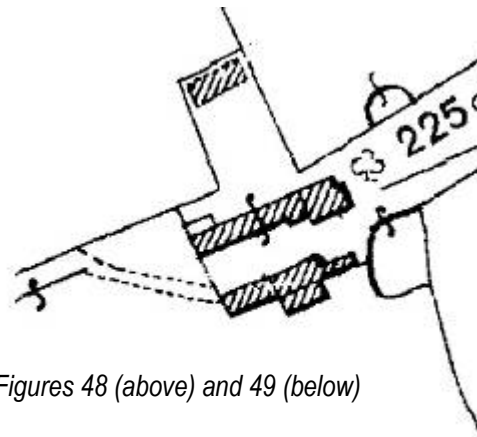

Figure 47 An L-plan range with house, stable and barn built in a single phase and a single storey cartshed attached to the house.

Parallel Plans

Parallel plans have been a relatively uncommon plan type in the areas that have been mapped to date. A Parallel plan consists of the farmhouse and a farm building lying close to and parallel to each other (Figures 48 and 49) the key feature is the narrow space between the two which is of a different character to the larger yard area seen in loose courtyard farmsteads. But for this fact Parallel plans are similar to Loose Courtyard plans with one farm building to the yard and the house set long to the yard.

Parallel plans are probably most closely associated with small pastoral farms where the animals were housed in cowhouses.



Figures 48 (above) and 49 (below)



Row Plans

Row plans are another relatively rare plan type. Rows consist of one or more ranges of working buildings attached in-line (Figure 50). Usually they are the result of incremental growth but some examples of particularly long single phase ranges could also be considered to be a Row plan.

Some Row plans are associated with yard areas and so also have a Multi-yard character which should be recorded as a Tertiary plan element

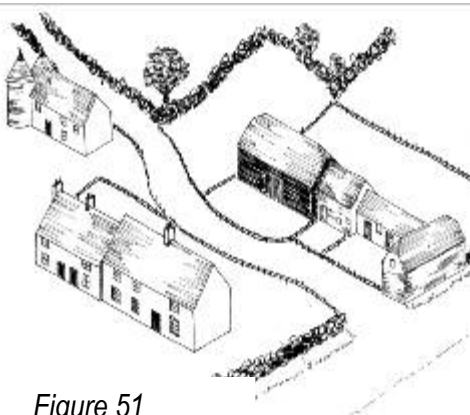

Figure 51

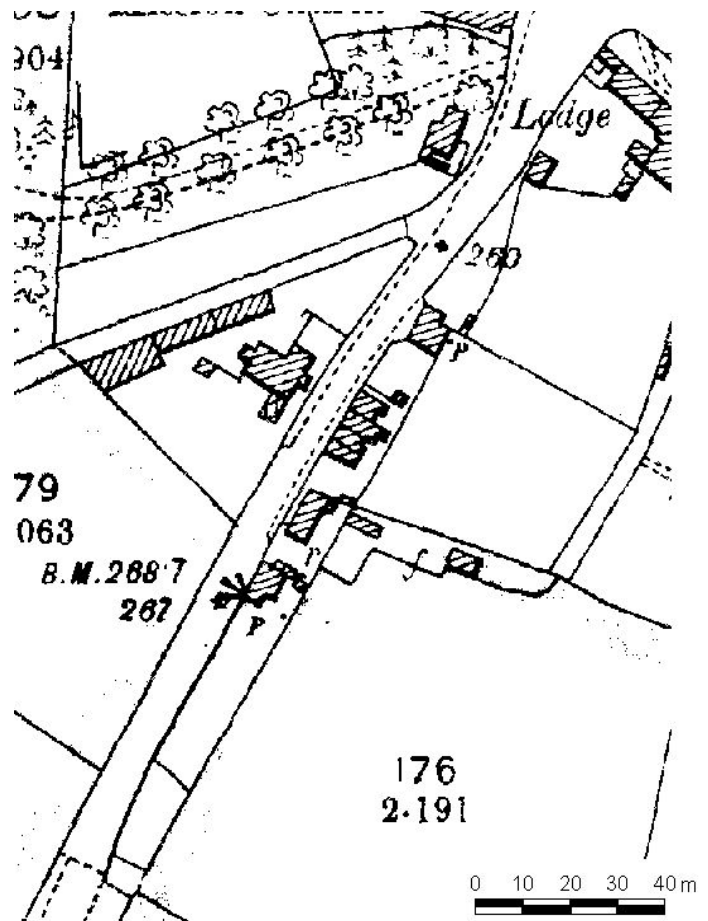

Figure 50

7.0 Small-holdings, Outfarms and Field Barns

7.1 Small-holdings

In certain landscapes farming was a small-scale enterprise that required few, if any, farm buildings. In such areas farming may have been a form of by-employment associated with industrial enterprises such as quarrying, coal or lead mining or metal working. The farmers of such areas often relied upon access to common land for grazing and may have little enclosed land.

Individual small-holdings may be difficult to identify with certain from historic mapping – their presence may be first informed by a general understanding of the economic and social history of a landscape. Small-holdings will often be identified by their location; being embedded in areas of small fields whereas cottages, which may be of a

similar size, will usually be set on roadsides without a clear association with fields.

Small-holdings may be important contributors to the character of the landscape and so should be mapped. This can be done individually although there may be no plan form to record – their presence and degree of change is the important issue. Alternatively, areas that contain numerous small-holdings can be mapped using a separate polygon data set to show the areas where small-holdings are an important element in the landscape.

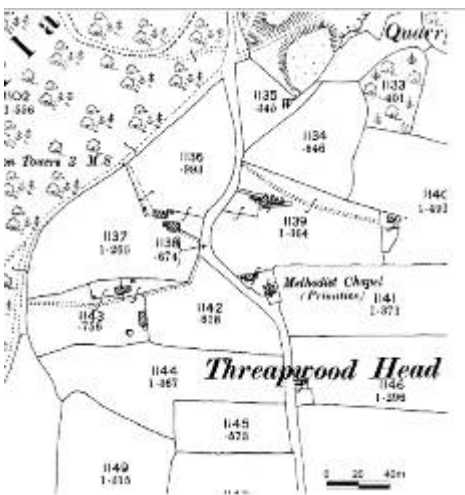
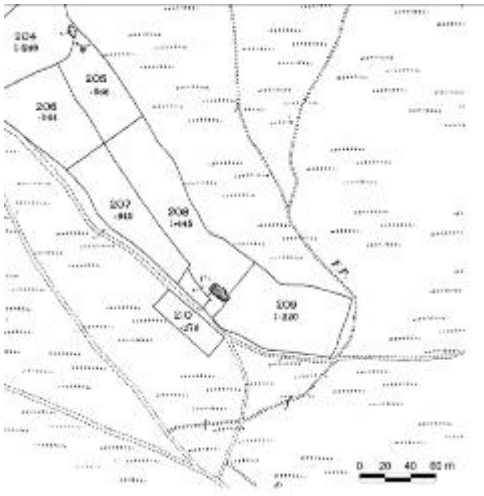

Figures 52 (top) and 53 (bottom)
Small-holdings, often associated with common edge settlement and industrial activities such as quarrying or mining.

7.2 Outfarms and Field Barns

Outfarms and field barns allowed certain functions normally carried out in the farmstead to be undertaken at locations remote from the main steading. This may include the processing and storage of crops, the housing of animals and the production of manure or tasks such as milking.

Depending on the size of the holding outfarms can range from full courtyard plans to small, single buildings standing in a field (Figures 54-57).

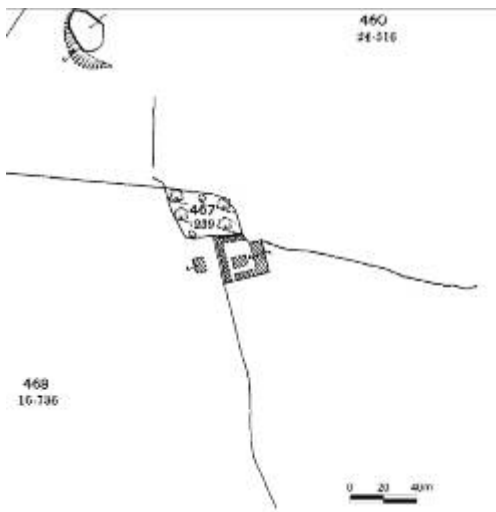

Figure 56 A Loose Courtyard outfarm group in the Hampshire Downs

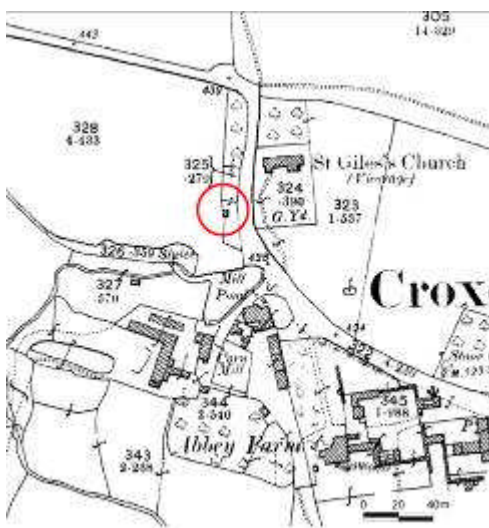

Figure 57 The small field barn shown in Figure 55

Figures 54 (top) A regular courtyard outfarm located within fields some distance from the farmstead. Such complexes may be accompanied by a labourer's cottage
Figure 55 (bottom) A small field barn on the edge of a village. This field barn is pictured in Figure 57

8.0 MAPPING OTHER ATTRIBUTES

8.1 Farmhouse Position

The position of the farmhouse in relation to the yard can follow localised patterns. The house may face into the yard (either with its front or rear elevation), be gable end on to the yard, detached from the working area or attached to a working building either forming part of a Linear range or a courtyard plan.

LONG	Farmhouse set lengthwise to the yard (Figure 1)
GAB	Farmhouse set gable end on to the yard (Figure 6)
DET	Farmhouse detached from yard (Figure 5)
ATT	Farmhouse attached to working buildings (Figure 43)
UNC	Uncertain – not able to identify which building (if any) is the farmhouse

8.2 Change

EXT	Farmstead is largely unaltered from late 19 th century form
ALT	Some noticeable change but less than 50% loss of buildings
ALTS	Considerable change – more than 50% loss of buildings
HOUS	Only the farmhouse survives - all working buildings have been lost
DEM	All buildings shown on late 19 th century map have been lost but site remains a farmstead
LOST	The farmstead site has been completely lost, either through redevelopment to another use (housing etc) or total demolition and removal from the landscape

The degree of change experienced by farmsteads in the period from the late 19th century to the present can be recorded by comparison between the 2nd Edition OS mapping and modern Mastermap. The

extent of change is grouped into one of six categories (Figure 58).

8.3 Modern Sheds

SITE	Modern sheds stand on all or part of the footprint of the historic farmstead
SIDE	Modern sheds positioned to the side of the footprint of the historic farmstead

Recording the presence of large modern sheds provides information regarding the present-day character of the farmstead and is a good indication as to whether a farmstead is still in agricultural use. A differentiation is made between examples where the large shed stand on the site of the historic farmstead or to the side (Figure 58). Whilst the presence of a modern shed on part or all of the footprint of the historic farmstead may imply the loss of the earlier buildings, this is not always the case; historic ranges may have been retained when yards were covered. In cases where Change is recorded is one of the categories of most change, recording the presence of large sheds on the site can act as a warning that there may be a lesser degree of change than is suggested by the mapping.

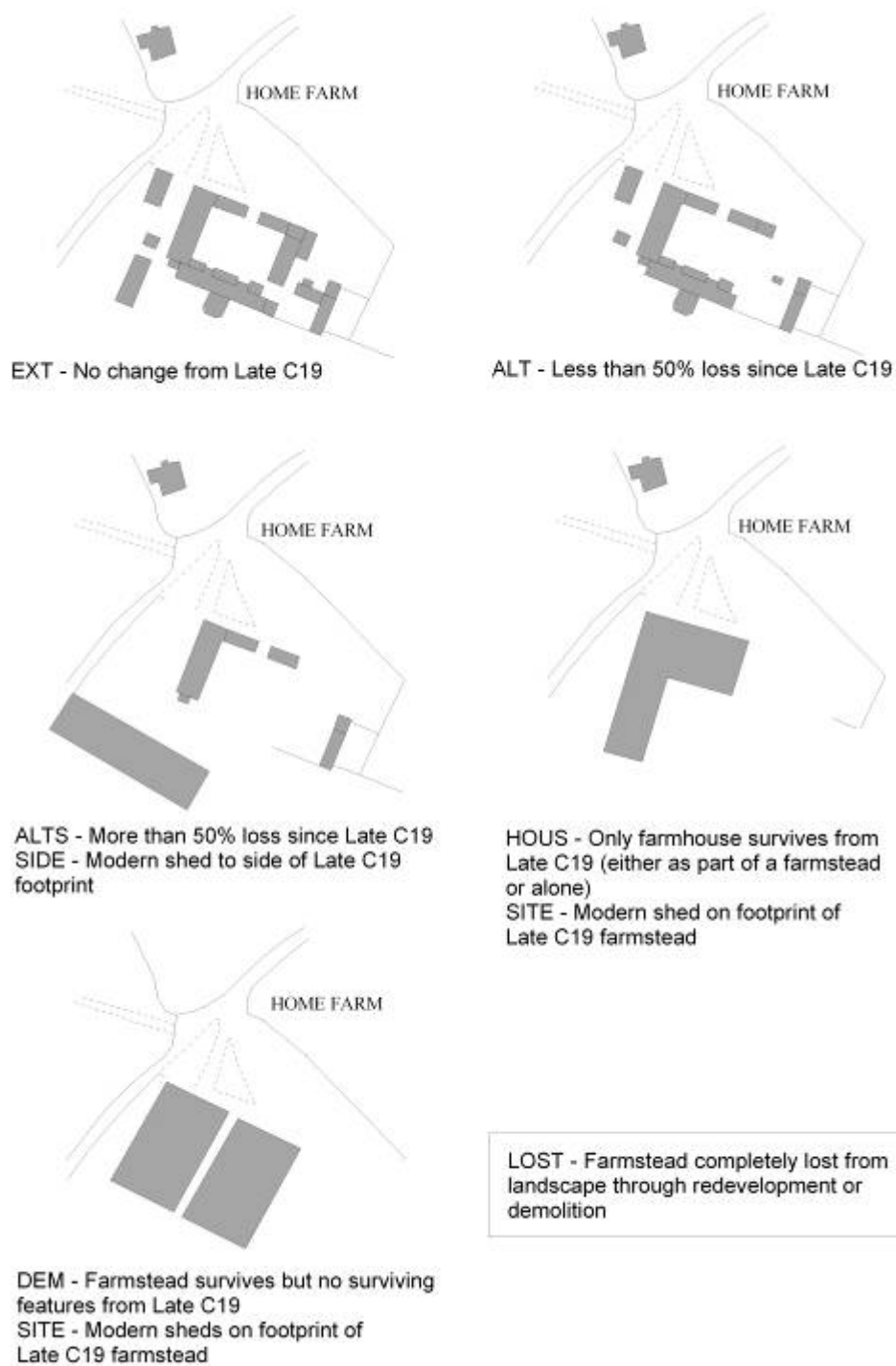

Figure 58
Farmstead change and the presence of modern sheds.
The EXT example represents the plan of the farmstead as shown on the late 19th century OS map.

8.4 Farmstead Location

The location of the farmstead in relation to other settlement, for example, a village or hamlet, is recorded.

VILL	Village. Farmstead is located within a nucleated village
HAM	Hamlet. Farmstead is located within a hamlet
FC	Farmstead Cluster. This term represents small loose groups of farmsteads where they are not sufficiently grouped to be regarded as a hamlet. A guide of c.300m between farmsteads has been used to date. In areas with a high density of small farmsteads the guide distance may be insufficient to identify farmstead clusters. The farmsteads will probably be linked by roads, tracks or paths.
CM	Church and Manor Farm or other higher status farmstead.
ISO	Isolated. Used where a farmstead is located in an isolated position in relation to other farmsteads and settlement.

8.5 Size

This field is used to record examples where the size of the farmstead is markedly smaller or larger than is usual for that particular plan type.

8.6 Confidence

Whilst the recording of many farmstead plans is relatively straightforward, there are times when the identification of the site as a farmstead or the classification of the plan type is less certain, especially for plan types such as Linear plans where there may be uncertainty that the site is a farmstead.

H	High confidence
M	Moderate confidence
L	Low confidence

8.7 Notes

The Notes field is a free text field where the recorder is able to note any additional information about the farmstead, for example, the presence of a particular building type such as haybarns or hop-kilns or an indication as to how the plan type was selected.

9.0 ANALYSIS AND REPORTING

The process of recording the location and plan form of farmsteads is the first stage in describing character. It is necessary to undertake analysis of the data with respect to the distribution of farmstead types and farmstead date against landscape character areas and historic landscape character area.

To date the reports produced for areas where farmsteads have been mapped have followed a similar format.

9.1 *Setting the context*

It is important to understand the context of the area being mapped. In particular the settlement pattern utilising Roberts and Wrathmell (2000) and any other local studies that have been carried out and the agricultural background. Whilst in many areas the majority of farmsteads will consist of buildings post-dating 1750, an understanding of the agricultural development of the area from the medieval period will be useful to describe how and when the present pattern of farmsteads developed. Sources will include the county reports published by the Royal Agricultural Society of England in the late 18th and early 19th centuries, the Agriculture chapters of Victoria County History volumes where available and the volumes of *The Agrarian History of England Wales* (Thirsk, various dates) and any regional or local studies of agriculture. Many of these studies will identify the agricultural regions of the area.

9.2 *Data Analysis*

This section analyses the farmstead data against the Joint Character Areas, county Landscape Character Areas and Historic Landscape Character Areas. After separating the farmsteads from outfarms and field barns the following distribution maps have been produced:

9.3 *Farmsteads by Date*

Pre-1600 Farmsteads
C17 Farmsteads
C19 Farmsteads
C19 Farmsteads dated through the presence of a C19 listed building
C19 Farmsteads identified from historic mapping only.

9.4 *Farmsteads by Plan Form*

Loose Courtyard Plans
Regular Courtyard Plans
Dispersed Plans
Linear Plans and L-Plans
Parallel Plans and Row Plans
Outfarms and Field Barns

Analysis should present basic statistics, for example, the numbers and percentage of any plan type within a character area. Whilst distribution maps are useful, it is important to also understand the relative proportion of any plan type in an area compared to another area.

9.5 *Conclusions*

The conclusion presents a summary of the key results identified by the mapping and analysis and also identifies any aspects of traditional farmsteads that require further research.

10.0 TEMPLATE FOR CHARACTER AREA DESCRIPTIONS

Number/ name of area

SUMMARY

Half to one-page summary under the key headings

Historic Development
Landscape and Settlement
Farmstead and Building Types
Materials and Detail
Pressures
Rarity and Significance
Research Questions

1 ***Historical Development***

National Background

Distinct agricultural regions have developed from the medieval period, mixing or specialising to differing degrees in the production of corn, livestock or dairy products. They have been influenced by patterns of landownership, communications, urban development and industry, as well as the nature and intensity of earlier land use. Agricultural productivity has long been sustained by new techniques in crop and animal husbandry, and the restructuring and enlargement of farm holdings. The period 1750-1880, and especially the capital-intensive 'High Farming' years of the 1840s-70s, saw a particularly sharp increase in productivity, followed by a long but regionally varied depression that lasted until the Second World War.

Outline the historical development of the area, noting where relevant the regional and national context.

2 ***Landscape and Settlement***

National Background

The distribution of farmsteads across rural areas displays a broad spectrum of patterns that can reach back into the medieval period and even earlier. These range from areas of nucleation, where communities have worked the land from villages with few or no isolated farmsteads, through a range of mixed settlement patterns to areas of dispersed settlement dominated by scattered dwellings and farmsteads. They are closely linked to the patterns of fields, open common areas, woodland and routeways, which also reveal changes over time. Fields are anciently-enclosed (generally of the 14th century or earlier), or reflect in their irregular or regular forms and boundaries the piecemeal or planned enclosure of earlier farmed landscapes or the taking in of new land for cultivation. The type of farming – ranging from the largest corn-producing farms to the smallest dairying or stock rearing farms – has also determined the size and density in the landscape of farms and their fields.

The purpose of this section is to help the reader understand how the farmstead can be read in relationship to the historic character and *coherence* of the surrounding landscape, and in particular the patterns of settlement, fields, routeways and woodland.

- Outline the patterns of settlement in the area, noting the extent to which farmsteads are located in villages, hamlets or are isolated.
- Note the historical linkage between farmstead location, access and patterns of landscape (field size and form, boundary form, routes and tracks, woodland and land cover). This can be done through providing an indication of the origins of farmsteads in different settlement/landscape contexts – i.e. are the village-based farmsteads medieval in origin, do they represent the growth of new farms on the edge of villages and occupying former plots, are isolated farms likely to have medieval origins (because they are located in landscapes of ancient enclosure, or do they occupy the sites of medieval monastic granges), or be linked to the processes of piecemeal or planned enclosure of communal fields and grazing areas ?
- What other visible traces of historic land use and settlement are present in the area (eg ridge and furrow, shrunken or deserted settlement, historic parkland and estate villages).

Farmsteads in Villages and Hamlets

- Farmsteads in villages and hamlets - often of medieval origin – are typically very prominent features with buildings visible from the public highways.
- They may relate to long former peasant holdings in strip form or as sites occupying many former steadings.
- Larger farmsteads typically absorbed earlier farmstead sites within or often on the edge of settlements, and may clearly relate to historic fields, routeways and features (such as ridge and furrow) resulting from historic land use.
- Villages also have houses and cottages which are no longer engaged in agriculture, and whose working buildings have been lost.

Isolated Farmsteads

Some isolated farmsteads are on sites of medieval high-status sites or relate to shrunken hamlets or villages and can be associated with earthwork remains of medieval settlements and associated field systems (eg ridge and furrow). Others can represent new sites established from the 16th century relating to piecemeal enclosure of the landscape of former open fields.

Consider in this section:

- How the density or sparsity of isolated farmsteads result from historical change and farmstead location, settlement and patterns of landscape (field size and form, boundary form, routes and tracks, woodland and land cover).
- What are the dominant landscape types – ancient, piecemeal or regular patterns of enclosure – and how are they linked to the density and distribution of farmsteads.
- What is the predominant date of isolated farmsteads – are they pre-1550 (medieval) because they are located in landscapes of ancient enclosure, or occupy the sites of shrunken settlements or estate farms (eg medieval monastic granges); are they sitting within landscapes of piecemeal enclosure from co-operative/communal strip fields or common land (and if so what the main date range of this enclosure); or are they in landscapes of mostly C18/19 regular surveyor-drawn enclosure which result from the reorganisation of earlier enclosed landscapes (where the farmsteads often retain pre-1750 buildings).

Farmstead/ Building Contribution to Historic Landscape Character	
Photograph/s showing how traditional farmsteads/buildings contribute to landscape character	Guidance to help user identify farmstead sites and types in relationship to historic landscape character (eg village area, assarted landscape, heathland, piecemeal or regular enclosure) and identification of farmstead/building types which contribute to this
One or two late 19 th /early 20 th century maps to show how farmsteads relate to landscape and settlement context	Explanatory text

3 Farmstead and Building Types

National Background

The character of farmsteads has been shaped by their development as centres for the production of food from the surrounding farmland. The principal function of farmsteads has been to house the farming family and any workers, store and process harvested crops and dairy products, provide shelter for livestock, carts and implements and produce manure for the surrounding farmland. Farmsteads required access to routes and tracks, and working buildings were placed in relationship to yards and other areas for stacking crops and managing livestock. Houses faced towards or away from the yard, and may be attached or detached from the working buildings. Variations in farmstead form, scale and dates reflect agricultural and local traditions, landownership, farm size and a variety of historic functions. Most traditional farmstead buildings date from the 19th century, survivals of earlier periods being increasingly rare. Over the 20th century – and especially since the 1950s – farmstead functions have been met in all areas by standardised sheds.

Introductory text should summarise the predominant dates, rarity and significance in a national context and places emphasis if needed on the functional drivers behind locally distinctive scales and forms of farmstead architecture.

For example, the Hampshire Downs. In common with other chalk downland areas in the south, the buildings of the farmsteads of the Hampshire Downs demonstrate the importance of arable farming but rarely do they reflect the importance of sheep. This was an area of large and capital intensive farms, there being extensive evidence for large barns and courtyard layouts dating from the 17th century and sometimes earlier. Increases in grain production and yields in the 18th and early 19th centuries often led to the construction of an additional barn and in many cases, the enlargement and adaptation of earlier barns. In this way many farms were provided with two or more barns and, in some cases, a saddle barn.

Rare/nationally significant farmstead types

- Farmsteads with pre-1550 buildings on monastic or secular estates (eg monastic grange farms and stock farms)
- Home farm groups in or on the edge of historic parkland with buildings relating to the working of an estate.

- Small-scale groups with vulnerable buildings (often using rare building fabric), concentrated in heathland and common-edge groups.
- Groups with one or more examples of pre-1750 buildings, particularly if identified as rare examples of building types (below).
- Groups with clear evidence for industrial production as a by-employment – eg Sheffield area steel, West Pennines cloth, South Somerset flax.
- Rare surviving examples of locally representative farmstead types – these will be noted in regional and character area descriptions.

Rare/nationally significant building types

Some building types can be easy to identify because they are highly specialised in function (such as dovecotes, pigsties and threshing barns) whilst the functions of other buildings or ranges of buildings may be more difficult to unravel because they are multi-functional. They all display significant variation both over time and regionally, and are closely related to the overall plan of the farmstead. Rare survivals are:

- examples of formerly common types, principally 18th century or earlier multi-functional barns, outfarms, stables, field barns and cattle housing;
- examples of unconverted building types eg threshing barns in areas of high conversion;
- highly specialised buildings, principally kilns for drying corn, maltings, dovecotes, sheep shelters, goose houses, well houses, smithies;
- buildings associated with non-agricultural/ industrial manufacture such as cloth (eg in the West Pennines), flax (eg in South Somerset) and cutlery (eg around Sheffield).

Farmstead Types

Representative farmstead types are those which – particularly the most coherent survivals (4 above) – have experienced little change in their historic (pre-1940, and usually late 19th century) form and make a major contribution to local distinctiveness, whether they have been planned or developed over a long period of time.

Note if there are any strong links between farmstead types and landscapes – eg regular U plans and regular enclosure landscapes/ loose courtyard farmstead in landscapes of piecemeal enclosure/ dispersed plans in landscapes of ancient enclosure.

Name of farmstead type	Description
Picture of farmstead type with principal buildings marked	Eg Small outfarms are characteristic of the Pennine Dales and typically comprise a haybarn with an attached byre. They relate to a landscape of small drystone walled hayfields. Rare examples at remote locations may include accommodation for labourers.

Building Types

Illustration and text will enable user to:

- Identify the building type. The scale, range and form of working buildings - or building types as described in further detail below - reflects their requirements for internal space and plan form, lighting and fittings. Some buildings were highly specialised in function (such as dovecotes, pigsties and threshing barns) whilst others combined in the individual rooms or sections of one range two or more functions.
- Identify typical features, fixtures and fittings that can be found.
- Understand what is particularly rare or significant.

Name of building type	Description
Picture of building type	List of typical fixtures and fittings (to enable user to then judge survival) Notes on significance Notes on both in annexe
Dovecote	Stand-alone dovecotes are rare in the North Pennines, but do occur on some larger farmsteads. They may sometimes form the upper story of buildings which combine a number of other functions such as cart shed or hen houses. Typical fixtures will include nest boxes, and access holes.

4 Materials and Detail

National Background

Historic farmsteads reflect England's huge diversity in geology, and differences in building traditions and wealth, estate policy, access to transport links and the management of local timber and other resources. This has contributed to great contrasts and variety in traditional walling and roofing materials and forms of construction, which often survived much longer on working farm buildings than farmhouses. Buildings in stone and brick, roofed with tile or slate, increasingly replaced buildings in clay, timber and thatch from the later 18th century. Building materials such as softwood timber, brick, slate and iron could also be imported onto the farm via coastal and river ports, canals and rail. There also appeared in the 19th century a range of standard architectural detail, such as part-glazed and ventilated windows and the use of cast and wrought iron for columns and other detail.

Prefabricated construction in industrial materials made its way onto farms from the 1850s, but did not become dominant and widespread until after the 1950s.

Consider dominant patterns of traditional (mostly vernacular) architectural style:

- Roofing form (gabled, hipped, half-hipped) and materials
- Walling materials and treatment

Additional notes for designed or industrial buildings if a significant contributor to landscape character in the area.

Rare original features are:

- Particularly vulnerable historic floors (eg lime ash floors, rush withy floors, threshing floors).
- Doors and windows of pre-19th century date, eg mullioned windows, sliding shutters to windows.
- Dairies with internal shelving etc, barns with *in situ* threshing machines and other processing machines, horse engine houses with internal gearing, oast houses with internal kilns and other detail, cider houses with internal mills and/or presses.
- Tramways to planned industrial complexes with good survival of other features (below).

Typical original features, of 19th and early 20th century date, are:

- Stalls and other interior features (eg mangers, hay racks) in stables and cattle housing of proven 19th century or earlier date.
- Doors (usually planked/ ledged and braced, from c1850 on horizontal sliding rails) with iron strap hinges and handles, and heavy frames.
- Windows, often of a standard type nationally, that are half-glazed, shuttered and/or with hit-and-miss ventilators.
- Historic surfaces such as brick, stone-flag and cobble floors to stables and cattle housing, with drainage channels.
- Industrial fittings (iron or concrete stalls, mangers etc) to planned and industrial complexes, including to inter-war county council smallholdings.

Secondary features are those which are not original to the building. For example, 20th century concrete cow stalling in a 19th century cowhouse.

The survival of these typical features is subject to a great deal of local and regional variation, and extreme rarity of survival should be noted if relevant.

5 Pressures

Consider:

- Vulnerability of types and materials;
- Coherence of farmsteads and landscapes (strong or weak locally distinctive quality?)
- The pressures for change in the area, using information from the Photo Image project and other data being updated by English Heritage.

6 Rarity and Significance

Guidelines that outline:

- The coherence of traditional farmsteads and their associated landscapes, informed by an understanding of post-1950 development and landscape change.
- The rarity of historic farmsteads and buildings in a regional and national context
- The key features (working from a landscape to building scale) that contribute to local character and distinctiveness

7 Research Questions

- What questions are needed to guide future research in the area?

ANNEXES: FARMSTEAD TYPES GUIDANCE

<p>Dispersed plans have no focal yard area. The buildings are clustered, set out around multiple dispersed yards or sited along a track.</p> <p><i>Select from this text as appropriate:</i></p> <p>These range greatly in size, and include farmsteads in hamlets where the buildings of different farms can be intermixed. They are most strongly concentrated in landscapes of ancient enclosure, and in particular where cattle rearing – and the need for separate contained areas for livestock – was historically important. Typical features are:</p> <ul style="list-style-type: none"> • an unplanned scatter of buildings, sometimes aligned to a route or track • the lack of a principal yard area • the siting of the farmhouse to one side or within the main group • buildings present many facets to the surrounding landscapes, which often provide open views into the groups • they are further exposed to view because dispersed plans are often dissected by public rights of way which provide access into the heart of the farmstead. 	<p>Image</p>
<p>Loose courtyard plans, have developed in piecemeal fashion around one or more sides a cattle yard, with or without scatters of other farm buildings close by. Typical features are:</p> <ul style="list-style-type: none"> • principal buildings facing one or more sides of a cattle yard, which usually faces south and east to capture sun and light • openings to these buildings facing the yards, external elevations having few if any openings with working buildings to one or more sides • cartsheds, sometimes stables and other ancillary buildings can be placed around the perimeter of the main group, facing towards routes and tracks • the farmhouse is typically detached and faces into its own garden area, and sometimes with its own entrance 	<p>Image</p>
<p>Regular courtyard plans can be arranged as full courtyard, L-, U-, and E-plan arrangements, always with one or more yards for the collection of manure. Buildings are carefully planned as linked ranges and often result from a single phase of building. They often display greater consistency in the use of materials and constructional detail, often employing more non-local materials like Welsh slate, than other farmstead types.</p>	<p>Image</p>

<p><i>Select from this text as appropriate:</i></p> <ul style="list-style-type: none"> • They can form L-, U-, and E-shaped plans or completely enclose all four sides of the yard • They can relate to whole individual steadings or comprise secondary elements in plans of other types • They are mostly 19th century in date, and can be strongly concentrated in landscapes enclosed and re-planned in the late 18th/19th centuries • The house is typically detached and faces away from the farm steading, often into its own garden • They have fewer openings to the outer elevations than to the internal cattle yards, which typically face south and east to capture sun and light • Cartsheds, sometimes stables and other ancillary buildings can be placed around the perimeter of the main group, facing towards routes and tracks 	
<p>Linear plans where houses and working buildings are attached and in-line, and which are now most common in northern and western pastoral areas.</p> <p><i>Select from this text as appropriate:</i> Here houses are attached to cattle housing and other working buildings. They are most common in western and especially northern areas of England. Some developed from <i>longhouses</i>, where people and animals shared the same entrance. They display a wide range in scale, from large farmsteads of independent Pennine yeoman-farmers to the smallholdings of miner-farmers. laithes</p> <p>All the buildings typically present one main elevation, facing onto a yard and a main entrance and circulation area. Stack yards and other working areas may be sited to the rear. As a result:</p> <ul style="list-style-type: none"> • the building range usually presents one main face to the surrounding landscape • the rear elevation of the range is relatively blank and free of openings • they include early surviving buildings or they are later farmsteads developed in areas of poorer soils such as heathland and moorland • they can be associated with loose scatters or yard arrangements of other farm buildings. 	Image
<p>Parallel plans, the least common type and where the agricultural buildings lie opposite the main house, which is sometimes a linear farmstead range.</p>	Image

<p><i>Select from this text as appropriate:</i> These often contain elements of earlier linear or L-plan elements within them:</p> <ul style="list-style-type: none"> • they have the farmhouse and an agricultural building lying parallel to each other with a small yard area between • the agricultural building stands behind or in front of the farmhouse. 	
<p>Field barns and outfarms, which are detached from the main group.</p> <p><i>Select from this text as appropriate:</i></p> <ul style="list-style-type: none"> • Outfarms, which include cattle yards and buildings and a barn for threshing corn or rooms for mixing feed; they may include a cottage for a farm worker and his family. • Combination barns, which comprise a single building incorporating a threshing barn and other functions such as housing stock • Field barns, either threshing barns or small structures for housing cattle and hay over winter. 	<p>Image</p>

BUILDING TYPES GUIDANCE

Format is:

Description

Typical Features:

Rarity and Significance:

These notes will be used and where necessary adapted for the text which will accompany the images in the full JCA character descriptions. The illustrated glossary in the HELM farmsteads toolkit website can provide fuller guidance, and the regional character descriptions provide fuller referenced detail.

The focus should be on principal building types, rather than descriptions of minor/occasional types (eg goose pens) as specified in the national targeting guidance and as also included in the draft illustrated glossary.

BARN

The **barn** was a building for the dry storage and processing of the harvested corn crop, and for housing straw after threshing before it was distributed as bedding for animals and trodden into manure to be returned to the fields.

Threshing Barns

The threshing barn was built to store and process grain crops, and for housing straw. Few were built after the mid 19th century, when the threshing process became mechanised.

Typical features:

- An area (the threshing floor) for beating by flail the grain from the crop and for winnowing the grain from the chaff in a cross draught.
- Doors on the side walls to the threshing floor, which was most commonly sited in the centre, and occasionally off-centre or at one end.
- Sometimes evidence in the form of belt drives and holes for drive shafts from earlier fixed or portable machinery.

Local variants to note in JCAs: barn size and numbers per steading; size of doors; porches and canopies; wheel houses if present.

Rarity and significance:

- These are typically the largest and earliest building on the farmstead. Pre-1750 examples are increasingly rare.
- Ritual and tally marks close to the threshing floor.
- Evidence for earlier (including medieval) reused timbers, and for holes (mortices) in the undersides of cross beams indicating former partitions and evidence for animal housing.
- In situ threshing machines are very rare.
- Wheel houses for housing horse-powered machines for threshing and other fodder processing machines in the barn have been highly vulnerable to removal, and surviving examples are rare.

Regional variations to note in JCA descriptions: Barns on large arable farms commonly had large opposing doors, sometimes with porches, into which a laden wagon would draw up

and unload the crop. In some pastoral-farming areas, especially in the north and west of the country, the doors to the threshing bay could be much smaller and the crop would be forked into the barn through pitching holes. Smaller winnowing doors were commonly provided in these areas.

Aisled barn

In an aisled barn the width of the building was increased through the use of aisles – narrow extensions along one or more sides or ends of the barn. The roof is carried on beyond the line of the aisle posts so the height of the walls is reduced and the visual mass of the roof increased.

Typical features: as threshing barns, evidence for animal housing in aisles in northern England

Rarity and significance: TO VARY DEPENDING ON JCA BEING DESCRIBED clear evidence for historic animal housing in northern England. Aisled barns are most strongly concentrated in East Anglia and the South East, and are generally associated with high-status buildings of the medieval period and sometimes later outside that area, including a group mostly dating from between 1570–1650 in the valleys in and around the southern Pennines. The latter had very different constructional techniques, and often accommodated stabling and cattle housing in the aisles.

Bank Barns

Typically bank barns have a threshing barn, sometimes with a granary and hayloft, sited above cattle housing, stabling and other functions such as cart sheds. They could be placed across the slope or along the slope.

Variant bank barn. Buildings of this form are built along the slope, with one gable built into the bank. They are more commonly isolated (field barns) than part of the steading.

Typical features: First -floor threshing floors. Sometimes granaries with grain bins and small windows. Ground floor may have retained historic stalls and flooring to stables and cowhouses.

Rarity and significance: Examples of pre-1750 date and those with historic stalling and granaries. They are concentrated in the Lake District, especially to the east, and occur elsewhere in upland areas from the Dark Peak northwards.

True bank barn. Buildings of this form are built along the slope, with the first floor entrance to the threshing barn at the upslope side.

Typical features: first-floor threshing floors, and sometimes granaries with grain bins and small windows. Ground floor may have retained historic stalls and flooring to stables and cowhouses.

Rarity and significance: Examples of pre-1750 date and those with historic stalling and granaries. They are characteristic of the Lakeland area of the North West Region and parts of Devon, Somerset and Cornwall in the South West Region, where they are typically the largest building (with the house) on the steading.

Variants to note in JCAs: 'chall barns' in W Devon and Cornwall

Combination Barns

A threshing barn that also housed cattle or horses, and sometimes other functions such as cart sheds and granaries.

Typical features: The same as threshing barns but in addition: Doors and windows to stables and cowhouses, and sometimes cartsheds with upper-floor granaries. Steps to granaries.

Rarity and Significance

- These are typically the largest and earliest building on the farmstead. Pre-1750 examples are increasingly rare.
- Examples with historic stalls and other features associated with granaries, stables, cowhouses.
- Combination barns with horses or cattle accommodated at one end are concentrated in lowland landscapes of dispersed settlement and ancient enclosure, and in northern and western England.

BASTLE HOUSE

Fortified house of two or three storeys, which offered farmers a defensive retreat where the family and stock could be secure from cattle rustlers in an area that remained lawless into the 17th century. In contrast to the tower houses with enclosed yards which were built between the late 14th and 16th centuries as refuges for high-status families and the tenants and inhabitants of an area, bastles were often built in clusters or even in villages.

Typical Features: The lower floor used to house animals and the upper for domestic use. The cattle were housed on the ground floor, usually with the doorway in a gable end, and the domestic space in a room above was accessed by a ladder or later an external staircase. With stone walls up to 1.2m thick, the bastle house and its walled enclosure (the barmkin). The addition of external staircases and the widening of windows became more common in the 18th century. The tradition of having domestic accommodation above animal housing continued into the 19th century in the form of Byre Houses.

Rarity and Significance: Highly significant part of the Borders history of Cumberland and Northumberland, and they extend southwards into the North Pennines. Bastle houses generally date from the 16th to the 17th centuries although some are earlier.

CART SHED

Open-fronted buildings which often face away from the farmyard and may be found close to the stables and roadways, giving direct access to the fields. In many areas cart sheds are combined with first-floor granaries, accessed by external steps.

Typical Features: Evidence for hatches for dropping sacks of grain from granaries into carts; hoists for hauling grain; steps to granaries with internal grain bins and louvred windows.

Rarity and Significance: Pre-19th century examples – especially with historic grain bins and other features associated with granaries - are rare.

They are characterised by being open-fronted and sometimes open at each end.

COWHOUSE

A building, or part of a multi-functional building, for stalling cattle (often dairy cattle).

Typical Features: Characteristic features of cattle housing include:

- Externally, lower and wider doorways than stables.
- Windows and other features to assist ventilation dating from the mid 19th-early 20th centuries eg hit-and-miss ventilators, and air ducts and ridge ventilators.
- Interior stalling and feeding arrangements. Cows were usually tethered in pairs with low partitions of wood, stone, slate and, in the 19th century, cast iron between them. Feeding arrangements can survive in the form of hayracks, water bowls and mangers for feed.

Rarity and Significance: Evidence for cattle housing is very rare before the 18th century, and in many areas uncommon before the 19th century. Very few cow-house interiors of the nineteenth century or earlier have survived unaltered because hygiene regulations for the production of milk have resulted in new floors, windows and stall arrangements being inserted. Any pre-19th century fittings including doors and windows are extremely rare.

Local variants to note: muck holes for ejecting manure, patterning of vents, arrangement of doors – gable end, side-entry etc

CIDER HOUSE

A building, usually part of a multi-functional range or combination barn, for storing the apple crop, processing them into cider and (sometimes) storing the drink in barrels.

Typical Features: A wide doorway allowing for the passage of barrels, occasionally the cider mill or press which if removed, they can leave distinctive scars within the interior.

Rarity and Significance: Cider houses that retain mills and/or presses are of particular importance. Cider could be kept for far longer than beer, and thus on some farms where cider was grown for export cider houses were built with storage for barrels.

COVERED YARD

A covered yard for the shelter of cattle and their manure, built from the 1850s.

Typical Features: Covered yards needed adequate ventilation, and could be provided with complex systems of louvres and shutters.

Rarity and Significance: Examples comprising part of coherent planned and model farm complexes of the 1850s to c1880, and later examples with architectural quality. Covered yards inserted into pre-existing open cattle yards from the late 19th century are much more common.

DAIRY

A detached building, or more often an upper room within the farmhouse, where milk was processed to make cheese and butter.

Typical features: externally wide doors and ventilated/shuttered windows, and internal shelves and brick/stone floors to keep interior cool.

Rarity and Significance: Original fixtures, such as slate or stone shelves for cooling the milk, are now very rare. Cheese rooms are now especially rare and hard to identify.

DOVECOTES

Structures for housing young birds and their manure. Dovecotes are usually square or circular towers with pyramidal or conical roofs, but a number of varying forms have been found.

Typical Features: Nest boxes, in the earliest examples formed in the thickness of the wall but usually in stone, brick or wood. Dovecote doorways were low to discourage the birds from flying out and often a potence, a central pivoted post with arms supporting a revolving ladder, provided access to the nest boxes for collection of the young birds (squabs) and eggs.

Rarity and Significance: Unusual and highly vulnerable building type, especially timber-framed examples. Surviving internal fittings are of great rarity, notably potences and nest boxes (especially the removable wooden types).

FIELD BARN

A farm building set within the fields away from the main farmstead, typically in areas where farmsteads and fields were sited at a long distance from each other. The key variations are those which were built to:

- House cattle and hay over winter
- In addition house and process corn
- House sheep

Field barns for cattle

Small building for housing cattle and hay over the winter months.

Typical features: Predominantly small scale with few openings. Mostly split level, with storage for hay above cattle housing. Typically sited within or on the edge of a field with no vehicular access. May retain historic stalling and floors.

Rarity and Significance:

- Because these are a common feature of the northern English uplands and some areas of western England, their significance (unless they are proven to have 18th century or earlier fabric/cores) is largely dependent on their contribution to landscape character and the historical coherence of those landscapes.
- Pre-19th century examples are very rare. These are typically with low eaves, steep-pitched roofs and partition to one or both ends. Those with historic roof carpentry (especially cruck frames) are particularly rare.

Field barns for corn

Threshing barns, sometimes with cattle/stack yards.

Typical features: as threshing barns. Usually provided with track for transport of harvested corn and for livestock.

Rarity and Significance: pre-19th century examples.

Field barns for cattle and corn

Multi-functional buildings – concentrated in north and west England - which have openings of different sizes to both floors and a large opening to the threshing floor. Projecting outshots for cattle are common, as extensions in-line or into an overall L-plan. Some have walled yard areas.

Typical features: historic stalling and floors. Usually provided with track for transport of harvested corn and for livestock.

Rarity and Significance: pre-19th century examples.

GRANARY

A building or room for storing grain after it has been threshed and winnowed in the barn, located in the farmhouse, an individual building or the upper floor of a multi-functional building.

Typical features:

- A separate external stair that gave access to the granary door.
- Ventilated openings - either louvres, shutters, sliding vents or grilles.
- Grain bins, or the slots in vertical timbers for horizontal planking used to make them.
- Close-boarded or plastered and limewashed walls, and a strong load-bearing floor construction with tight-fitting lapped boards to prevent loss of grain.
- Steps at the gable end to the first floor granary, if located above the stable and/or cartshed, or at the end of a multi-functional range.

Rarity and Significance: Most are of late 18th or 19th century date, earlier examples being of great rarity and including:

- Small, square or rectangular structures raised above ground level on mushroom-shaped staddle stones or brick arches and accessed by moveable wooden steps. Examples are concentrated in East Anglia and southern England from Kent to Cornwall. The larger free-standing granaries were of two, or even three, floors.
- The upper floors of buildings. Evidence (now very rare) for granaries in the upper floors of barns survives from the 14th century. There are early timber-framed examples in parts of the grain-growing south and east.

HAY BARN

Hay barns are typically open-sided structures with roofs supported on high brick, stone, timber or iron piers.

Rarity and significance: Examples which form part of coherent traditional farmstead groups. A very small number, mostly in Yorkshire, of timber hay barns with adjustable roofs – as commonly survive in the Netherlands – survive intact.

HOGG HOUSE

A field barn for the hogs or yearling sheep to give them protection over their first winter.

Typical features: Similar to field barns, but distinguished by much lower floor-to-ceiling heights and upper floor haylofts are characteristic features of these buildings. Associated yards and enclosures for sorting sheep etc.

Rarity and Significance: Concentrated in the uplands of northern England, particularly the Yorkshire Dales, North Pennines and the Lake District. Particularly significant are examples which form part of coherent historic landscapes with other traditional buildings and including small enclosures close to the hogg houses for sorting sheep etc. Pre-19th century examples are very rare.

KILN

Kiln. A structure or building for the drying of crops.

Typical features: a small building with a slatted floor (usually stone or brick) for drying harvested crops above a kiln.

Rarity and Significance: Surviving examples of corn drying kilns, concentrated in upland farming areas, are extremely rare. The term kiln is also used in Herefordshire and Worcestershire for *oast houses*.

LAITHE HOUSE

A linear range of one construction comprising a farmhouse with attached barn and usually a stable. There is no internal link between the house and the agricultural element of the range. The word 'laithe' or 'lathe' is a northern English dialect word for a barn, or a combined barn and cow house.

Typical features: The house and farm buildings are usually of one build, but there is no cross passage or inter-connection between them.

Rarity and Significance: Examples date from the mid-17th century but are not common until after 1750, with a concentration in the 1780–1840 period. They typically served farms of about 30 acres or less, and are most densely concentrated in the Pennine part of West Yorkshire and Lancashire, where dual income from farming and industry – primarily textiles, but also lead working – enabled smallholdings to be economically viable.

LINHAY

Two-storeyed and open-fronted building for cattle, with hay loft or tallet above cattle.

Typical features: The tallet may be constructed as a conventional floor or simply created from poles. Linhays can range in size from a single bay to L- and U-shaped ranges of over twenty bays, and are always associated with yards for cattle. The linhay can face into the principal farmyard or be set within its own yard.

Rarity and Significance: Linhays are characteristic of Devon, eastern Cornwall, west Dorset and south Somerset. The shorter and milder winters in south-west England enabled cattle to be over-wintered in open-fronted rather than enclosed buildings. Examples date from the 16th century, and so they comprise one of the earliest forms of cattle housing that can be found in England.

It is quite usual to find that part or all of the open-fronted side, especially the upper part, was later boarded up: this was an alteration associated, at least in parts of the Region such as north Devon, with the development of the dairying industry (and the need to shelter cattle indoors) in the later 19th century.

OAST HOUSE/HOP KILN

A building in which hops are dried and stored, known as a hop kiln in the West Midlands and an oast house in south-east England.

Typical features: An oast house comprises:

- A square or circular kiln, with a cowl on the roof that would extract air through the drying floor on which the hops were laid.
- An attached 'stowage' where the dried hops could cool before being pressed into hanging 'pockets' suspended from the upper floor.

Rarity and Significance: Early purpose-built oast houses, small buildings which included a kiln and rooms for the green and dried hops, are extremely rare. Evidence for early kilns may survive in some threshing barns. Surviving kilns are extremely rare.

Variations: combination with cider houses in West Midlands.

OUTFARM

Outfarm. A complex of buildings set within the fields away from the main farmstead, which saved on the labour needed to transport crops and manure to and from distant fields.

Typical features: Outfarms were typically built with shelter sheds for cattle flanking the barn and yard. A cottage for a farm worker could also be sited nearby. Degree of access to routes and tracks varies.

Rarity and Significance: They were concentrated from the late 18th century in areas where large and arable-based farms developed (especially wolds and chalk downs). Once redundant, they have always been very prone to dereliction and decay.

PIGSTY

A building for housing pigs. The main requirements for special accommodation were for farrowing, final fattening and accommodation of the boar.

Typical features: Pigsties were typically built as single-storey structures comprising individual boxes, individually or in rows and with external feeding chutes. They were often built with their own individual yards. Some had upper floors with poultry houses. A small chimneystack could mark the position of a boiler house for boiling swill for pig feed. Sties were often placed near the kitchen or dairy, because pigs were normally fed on kitchen scraps or whey (a by-product of dairying).

Rarity and Significance: Any pre-19th century examples are very rare. Significant if part of coherent farmstead groups. Large numbers of pigs were concentrated in dairying areas or market-gardening areas, and on larger farms where commercial fattening was practised.

SHELTER SHED

An open-fronted structure for cattle facing onto cattle yards. Internal cattle yards typically face south and east to capture sun and light, the openings being concentrated on the yard sides of the buildings.

Typical features: Cattle yards with open-fronted sheds were typical of mixed farming areas where cattle were housed on the steading as fatstock and for their manure. Common internal fittings were mangers and hayracks, and sometimes stalls. Floors, of earth, stone flags/cobbles and from the mid-19th century of engineering brick, sloping to a drainage channel.

Rarity and Significance: 18th century or earlier examples are very rare and significant examples of early cattle housing.

STABLE

A building, or part of a building, for housing horses and their harnessing and tackle.

Typical features: Stables are usually two-storey and well-lit buildings, with ground-floor windows, pitching openings and ventilation to the first-floor loft and an external staircase. They can be distinguished from cow houses as they have tall and relatively narrow doors. Single-storey stables, commonly with cast-iron ridge vents, were built from the later 19th century.

Interiors have:

- Wooden or cast-iron (for high-status or late examples) stalls with access to manger and hayrack.
- Floors, of earth, stone flags/cobbles and from the mid-19th century of engineering brick, sloping to a drainage channel.
- Pegs for harness and tack, sometimes in a separate harness room with fireplace.
- Sometimes chaff boxes for storing feed, and cubby-holes for lanterns, grooming brushes, medicines etc.

Rarity and Significance: After the barn, the stable is often the oldest building on the farmstead. A few stables dating to before 1700 have been identified in local surveys, while many more date from the 18th century. One of the reasons for this rise in number was the decline in the use of oxen.

The largest stables are concentrated in corn-producing areas, where farms were larger and more horses were need for ploughing and many other tasks. Fewer horses were needed in cattle-rearing or dairying areas.

STADDLE BARN

A threshing barn, usually timber framed and raised on staddle stones.

Typical features: a threshing barn, with opposing doors to the threshing floor, which usually timber-framed. Threshing floors and other features typical of threshing barns may survive.

Rarity and Significance: Staddle barns date from the later 18th and early 19th centuries and are a very distinctive but vulnerable features of the chalk downland areas of Hampshire, Berkshire and Wiltshire.

WHEEL HOUSE

A structure which housed a horse-engine for powering threshing and fodder-processing machinery, and typically found projecting from barns. Also known as a gin gang in northern England.

Typical features: a square, circular or polygonal structure extending from the side and (less commonly) end wall of a barn, which may be closed or open-sided.

Rarity and Significance: Wheel houses have been very prone to demolition once redundant. Surviving horse wheels are extremely rare. Early examples are concentrated in the North East (where rural wages were high) and few date from after the 1850s when portable machines became more common. In the southern counties, where labour was cheap and abundant until the 1850s or later, few barns bear evidence for the introduction of machinery.

THESE AND OTHER BUILDING TYPES MAY FORM PART OF MULTI-FUNCTIONAL RANGES. WHERE MULTI-FUNCTIONAL RANGES ARE ILLUSTRATED, THESE CAN BE DESCRIBED.

EG Mixing room. A room in a farmstead where grain, cake and roots for animals would be prepared, usually with the aid of machinery such as chaff cutters, cake breakers and root crushers.